



## B5-43SUN-JD

### DESCRIPTION

- Super bright LED Lamp
- Round type
- T1-3/4 (5mm) diameter
- Lens color: Water Clear
- With Flange
- Solder leads without stand-off
- Compliant with RoHS

### FEATURES

- Emitted color: Warm White
- High Luminous intensity
- Technology: InGaN
- Typical emission color:  $x=0.45, y=0.41$
- Viewing angle:  $30^\circ$

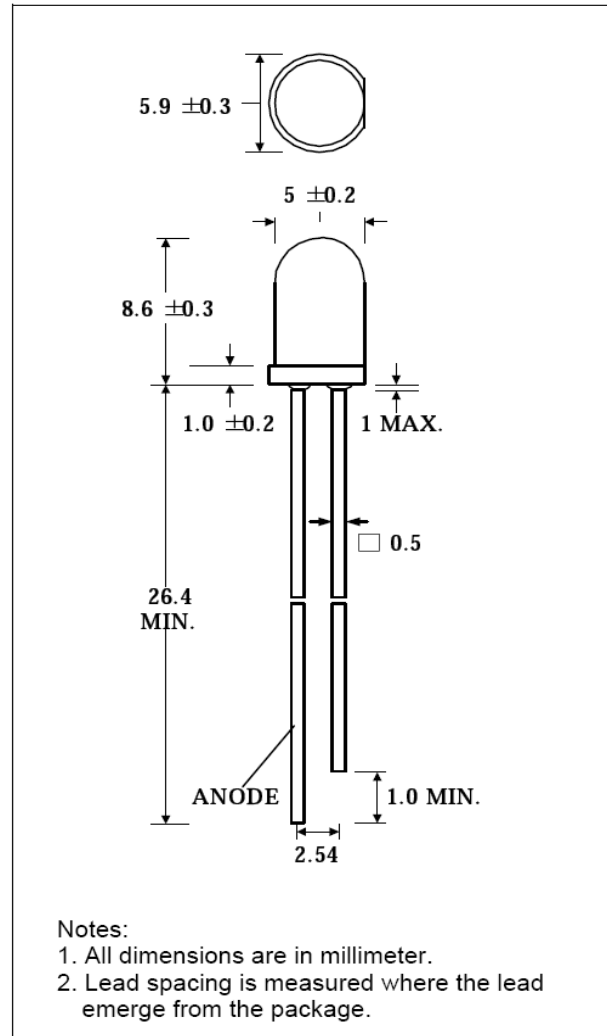

### SELECTION GUIDE

Chip Material	Emitted Color	Lens Color	Viewing Angle
InGaN	Warm White	Water Clear	$30^\circ$

Date	2006/11/24	Maker	Jay	Approver	J.C.Chi	Version	A	Page	1/3
------	------------	-------	-----	----------	---------	---------	---	------	-----



## ABSOLUTE MAXIMUM RATINGS

(Ta=25°C)

PARAMETER	SYMBOL	MAX. RATING	Unit
Power Dissipation	P <sub>D</sub>	120	mW
Peak Forward Current (1/10 Duty Cycle @1KHz )	I <sub>FP</sub>	100	mA
Continuous Forward Current	I <sub>F</sub>	30	mA
Reverse Voltage	V <sub>R</sub>	5.0	V
Operating Temperature Range	T <sub>OPR</sub>	-40~+85	°C
Storage Temperature Range	T <sub>STG</sub>	-40~+100	°C

Solder temperature 1.6 mm from body for 3 seconds at 260°C

## OPTICAL-ELECTRICAL CHARACTERISTICS

PARAMETER	SYMBOL	TEST CONDITION	MIN	TYP	MAX	UNIT
Luminous Intensity	I <sub>V</sub>	I <sub>F</sub> = 20mA	2300	3500		mcd
Forward Voltage	V <sub>F</sub>	I <sub>F</sub> = 20mA		3.5	4.0	V
Reverse Current	I <sub>R</sub>	V <sub>R</sub> = 5V			10	uA
Viewing Angle	2θ1/2	I <sub>F</sub> = 20mA		30		deg.

\*Tolerance of Viewing Angle: -10 / +5 deg.

Date	2006/11/24	Maker	Jay	Approver	J.C.Chi	Version	A	Page	2/3
------	------------	-------	-----	----------	---------	---------	---	------	-----



## TYPICAL OPTICAL-ELECTRICAL CHARACTERISTIC CURVES

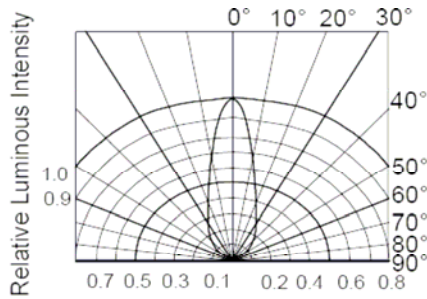

**RADIATION DIAGRAM**

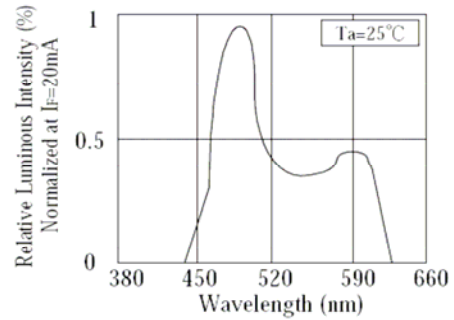

**RELATIVE LUMINOUS INTENSITY Vs. WAVELENGTH**

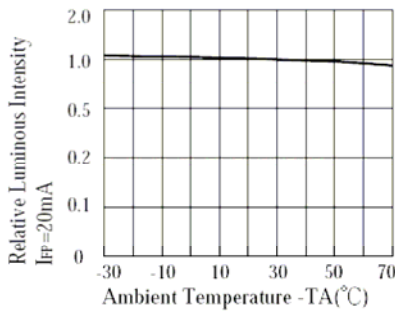

**LUMINOUS INTENSITY Vs. AMBIENT TEMPERATURE**

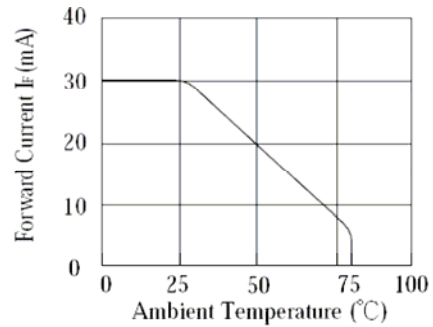

**MAX FORWARD CURRENT Vs. AMBIENT TEMPERATURE**

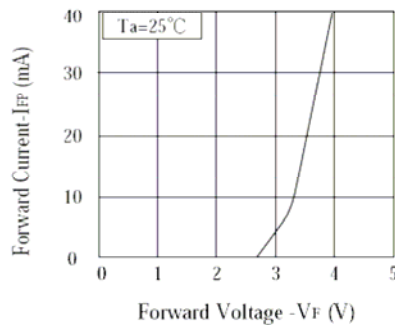

**FORWARD CURRENT Vs. FORWARD VOLTAGE**

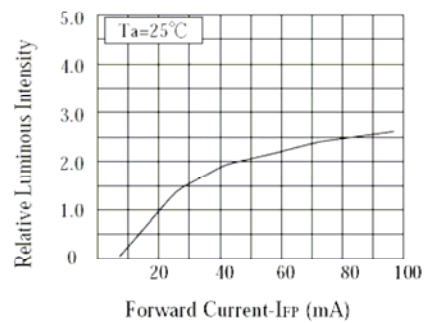

**LUMINOUS INTENSITY Vs. FORWARD CURRENT**

Date	2006/11/24	Maker	Jay	Approver	J.C.Chi	Version	A	Page	3/3
------	------------	-------	-----	----------	---------	---------	---	------	-----