



## B5B-430-JB

### DESCRIPTION

- Super bright LED Lamp
- Round type
- T1-3/4 (5mm) diameter
- Lens color: Water Clear
- With Flange
- Solder leads without stand-off
- Compliant with RoHS

### FEATURES

- Emitted color: White
- High Luminous intensity
- Technology: InGaN
- Typical emission color: x=0.31, y=0.32
- Viewing angle: 8°

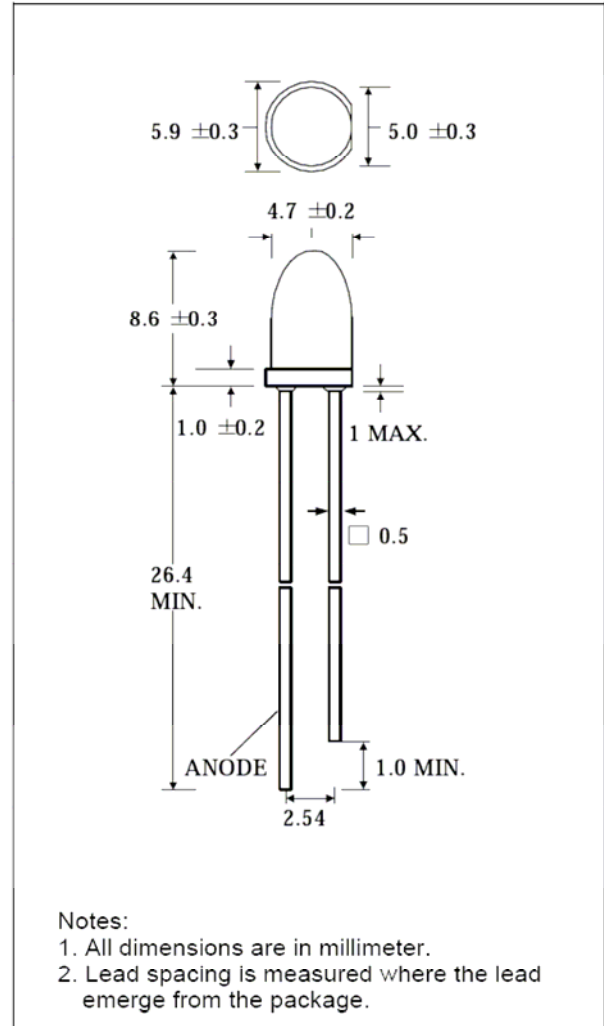

### SELECTION GUIDE

Chip Material	Emitted Color	Lens Color	Viewing Angle
InGaN	White	Water Clear	8°

Date	2006/11/24	Maker	Jay	Approver	J.C.Chi	Version	A	Page	1/3
------	------------	-------	-----	----------	---------	---------	---	------	-----



## ABSOLUTE MAXIMUM RATINGS

(Ta=25°C)

PARAMETER	SYMBOL	MAX. RATING	Unit
Power Dissipation	$P_D$	120	mW
Peak Forward Current (1/10 Duty Cycle @1KHz )	$I_{FP}$	100	mA
Continuous Forward Current	$I_F$	30	mA
Reverse Voltage	$V_R$	5.0	V
Operating Temperature Range	$T_{OPR}$	-40~+85	°C
Storage Temperature Range	$T_{STG}$	-40~+100	°C

Solder temperature 1.6 mm from body for 3 seconds at 260°C

## OPTICAL-ELECTRICAL CHARACTERISTICS

PARAMETER	SYMBOL	TEST CONDITION	MIN	TYP	MAX	UNIT
Luminous Intensity	$I_V$	$I_F = 20mA$	4600	7000		mcd
Forward Voltage	$V_F$	$I_F = 20mA$		3.5	4.0	V
Reverse Current	$I_R$	$V_R = 5V$			10	uA
Viewing Angle	$2\theta_{1/2}$	$I_F = 20mA$		8		deg.

\*Tolerance of Viewing Angle: -10 / +5 deg.

Date	2006/11/24	Maker	Jay	Approver	J.C.Chi	Version	A	Page	2/3
------	------------	-------	-----	----------	---------	---------	---	------	-----



## TYPICAL OPTICAL-ELECTRICAL CHARACTERISTIC CURVES

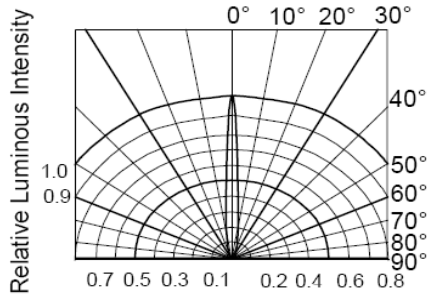

**RADIATION DIAGRAM**

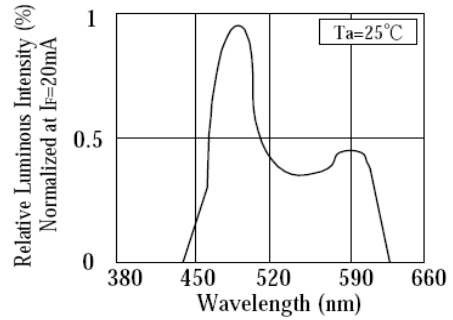

**RELATIVE LUMINOUS INTENSITY Vs. WAVELENGTH**

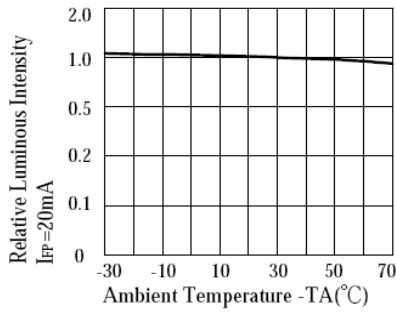

**LUMINOUS INTENSITY Vs. AMBIENT TEMPERATURE**

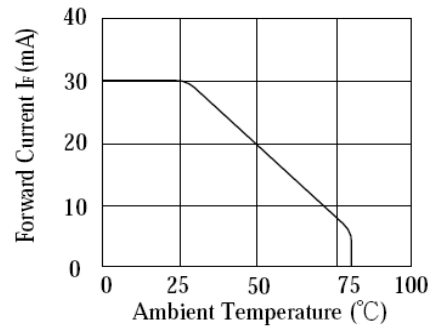

**MAX FORWARD CURRENT Vs. AMBIENT TEMPERATURE**

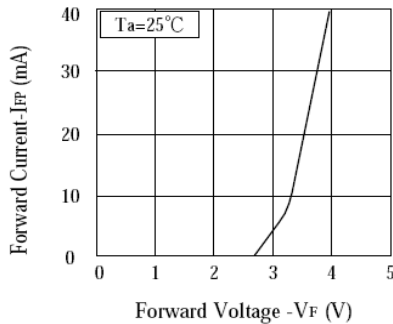

**FORWARD CURRENT Vs. FORWARD VOLTAGE**

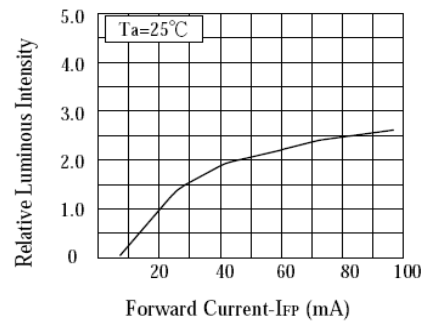

**LUMINOUS INTENSITY Vs. FORWARD CURRENT**

Date	2006/11/24	Maker	Jay	Approver	J.C.Chi	Version	A	Page	3/3
------	------------	-------	-----	----------	---------	---------	---	------	-----