



Model: NS365L-5CFA

Absolute maximum ratings

Item	Symbol	Maximum rating	Unit
DC forward current	I_F	25	mA
Pulse forward current*1	I_{FP}	100	mA
Power dissipation	P_D	100	mW
Operating temperature	T_{OPR}	-30 to +80	°C
Storage temperature	T_{STG}	-30 to +100	°C
Soldering temperature	T_{SOL}	260°C within 10 seconds	

*1 Conditions: duty cycle $\leq 1/10$, pulse width ≤ 0.1 msec

Optical and electrical characteristics (Ta=25°C)

Item	Symbol	Condition	Min.	Typ.	Max.	Unit	
Forward voltage	V_F	$I_F=20$ mA	3.2	3.6	4.2	V	
Peak wavelength*2	λ_p	$I_F=20$ mA	363	-	370	nm	
Full width at half maximum	$\Delta\lambda$	$I_F=20$ mA	-	15	-	nm	
Optical output power *3	Rank 2	P_o	$I_F=20$ mA	0.4	-	0.6	mW
	Rank 3			0.6	-	0.8	mW
	Rank 4			0.8	-	1.2	mW

*2 Measurement error: ± 2 nm

*3 Measurement error: 10%

Cautions

- (1) The LEDs emit very strong UV radiation. Do not look directly at the LEDs. UV radiation can harm your eyes. To prevent inadequate exposure of UV radiation, wear UV protective glasses.
- (2) The LEDs are very sensitive to static and surge. Take a full protection against static and surge.
- (3) The powered LEDs generate heat. Heat dissipation should be considered in the application design to avoid the environmental conditions for operation in excess of the absolute maximum ratings.
- (4) The leads should be bent at minimum 1.5mm away from the base of header. The LEDs should be soldered at minimum 3mm away from the base of header.
- (5) The LEDs are intended to be used for ordinary electronics equipment. Do not use the LEDs for the applications that may require a higher reliability and security and that the failure or malfunction of the LEDs may threat to life.
- (6) Do not reverse engineering by disassembling or analysis of the LEDs without our consent. If there's any defectives found, please contact our sales division.



■ Optical and electrical characteristics

■ Forward voltage vs. Forward current

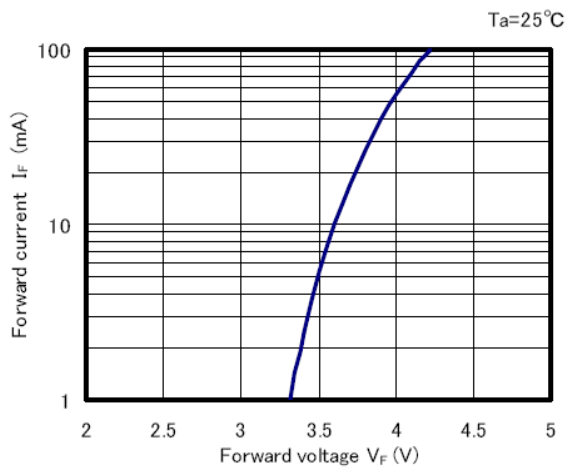

■ Forward current vs. Relative output power

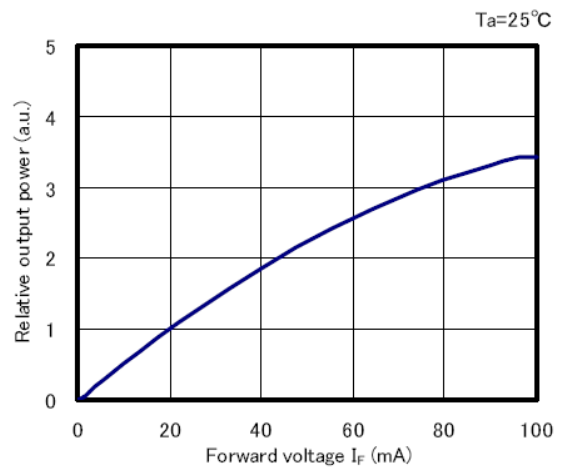

■ Ambient temperature vs. Relative output power

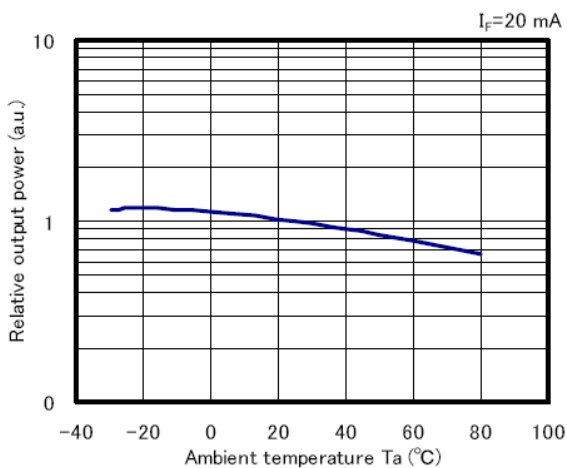

■ Ambient temperature vs. Forward voltage

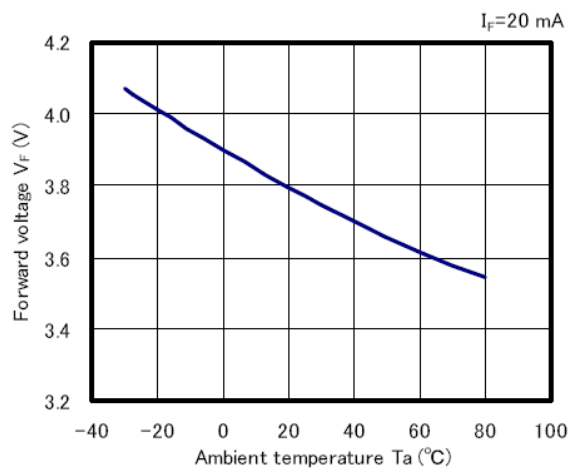



■ Ambient temperature vs. Allowable forward current

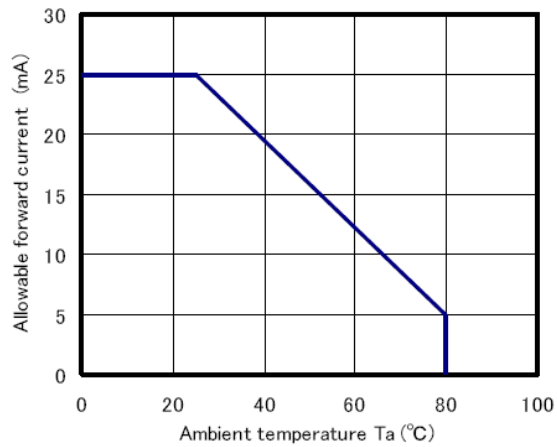

■ Spectrum

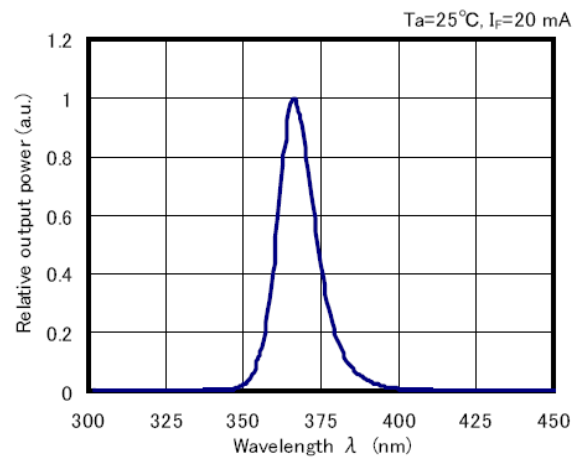

■ Ambient temperature vs. Peak wavelength

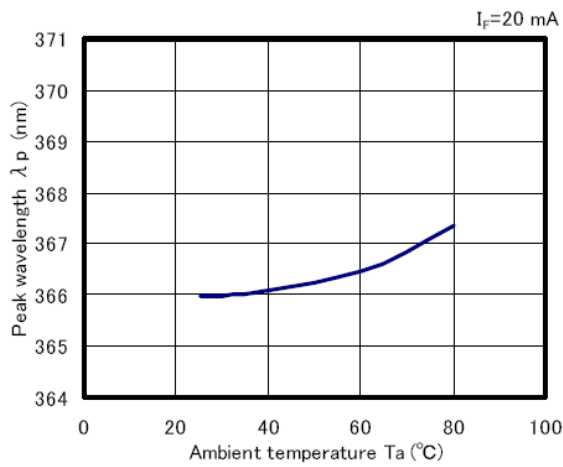

■ Directivity

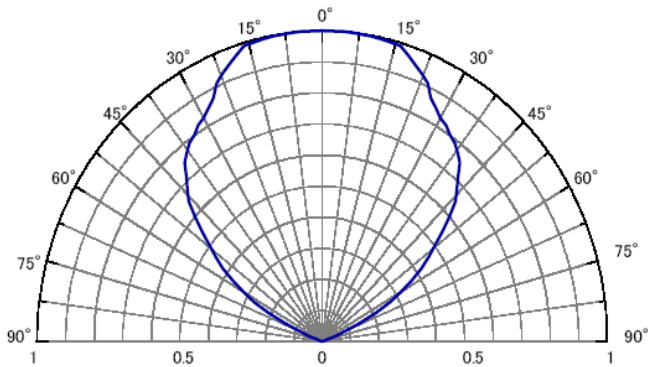



■ Dimensional outline drawing

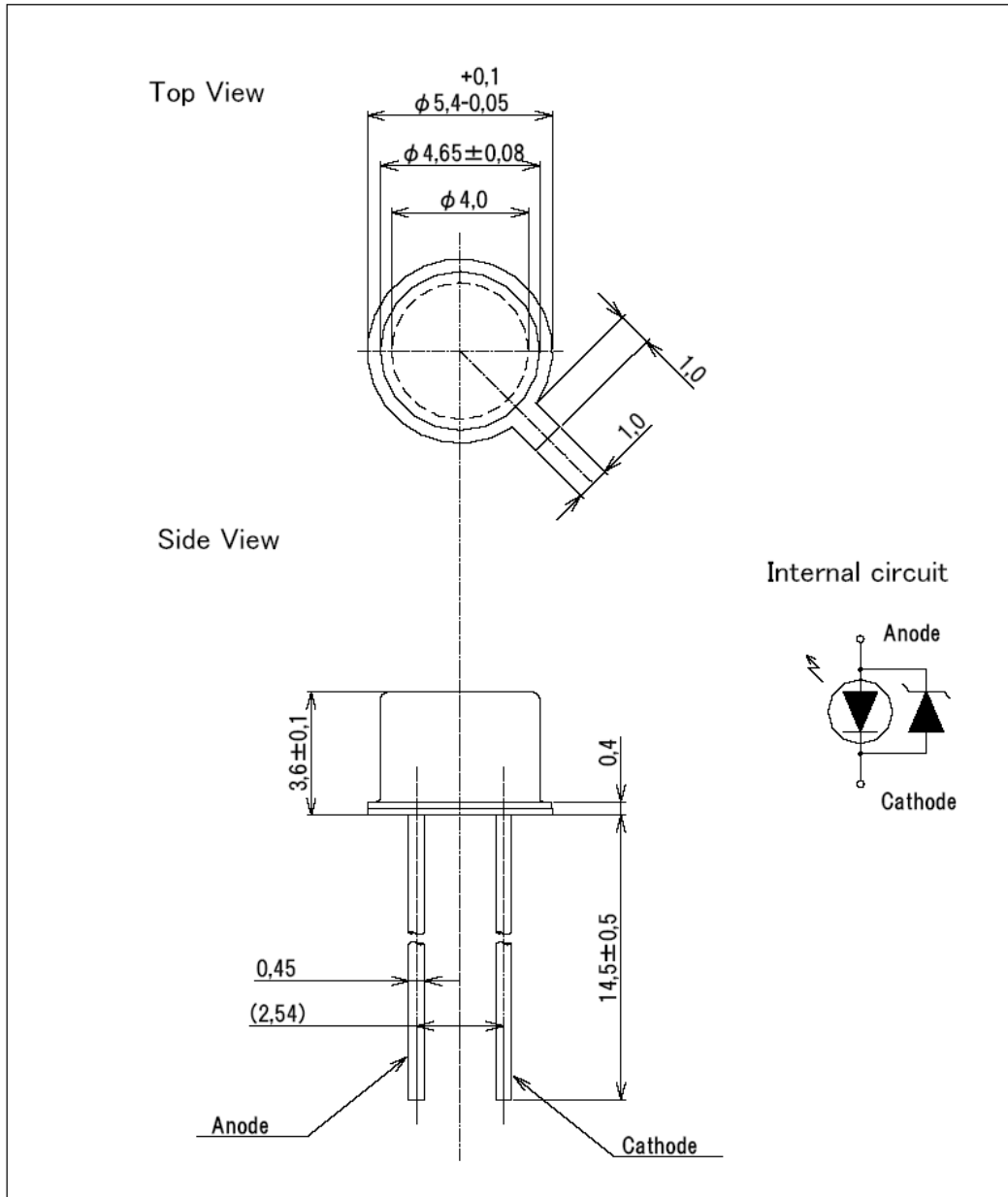

*A zener diode is built in the protective circuit against static electricity.

	Material
Glass lens	Hard glass
Header	Ni-plated iron alloy
Lead	Au-plated iron alloy