



ADL-83Y01TL

- Infrared Laser Diode
- 830 nm, 200 mW
- Small far field angle
- TO56 package, Flat Window



Description

ADL-83Y01TL is an infrared laser diode, typically emitting at 830 nm, with a nominal output power of 200 mW. It features high performance and reliability operation with a maximum operating temperature of 60°C. It is an efficient radiation source for many industrial applications. **ADL-83Y01TL** comes in 5.6 mm TO-Can package **with integrated PD**.

Maximum Rating* (T_{CASE} = 25°C)

Parameter	Symbol	Values		Unit
		Min.	Max.	
Optical Output Power*1	P _O (CW)		210	mW
LD Reverse Voltage	V _{RLD}		2	V
PD Reverse Voltage	V _{RPD}		30	V
PD Forward Current	I _{FPD}		10	mA
Operating Temperature*1	T _{OPR}	- 10	+ 60	°C
Storage Temperature	T _{STG}	- 40	+ 85	°C
Soldering Temperature (max. 3s)	T _{SOL}		+ 260	°C

* operating outside these conditions may damage the device

*1 operating at or close to maximum ratings may influence the life time



Electro-Optical Characteristics (T_{CASE} = 25°C, P_O=200 mW)

Parameter	Symbol	Values			Unit	
		Min.	Typ.	Max.		
Peak Wavelength	λ _P	820	830	840	nm	
Optical Output Power	P _O		200		mW	
Operating Voltage	V _F		1.9	2.4	V	
Threshold Current	I _{th}		65	95	mA	
Operating Current	I _F		265	350	mA	
Monitor Current (V _{RD} =5 V, P _O =200 mW)	I _M	0.5	0.9	2.2	mA	
Slope Efficiency (P _O =150-200 mW)	η	0.8	1.0		W/A	
Beam Divergence (FWHM)	parallel	θ	5	7	12	deg.
	perpendicular	θ _⊥	10	14	20	deg.
Beam Divergence accuracy (FWHM)	parallel	Δθ	-3		+3	deg.
	perpendicular	Δθ _⊥	-3		+3	deg.
Emission Point Accuracy	Δx, Δy		-80		+80	μm
	Δz		-80		+80	μm



Performance Characteristics

Output Power vs. Operating Current

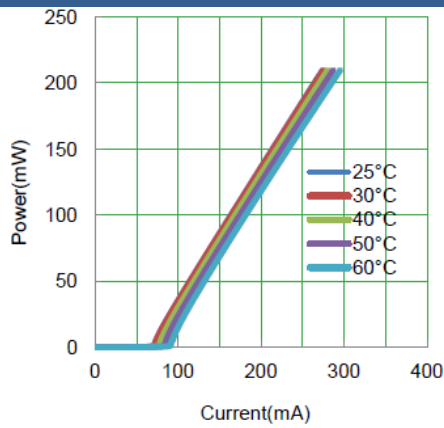

Operating Voltage vs. Operating Current

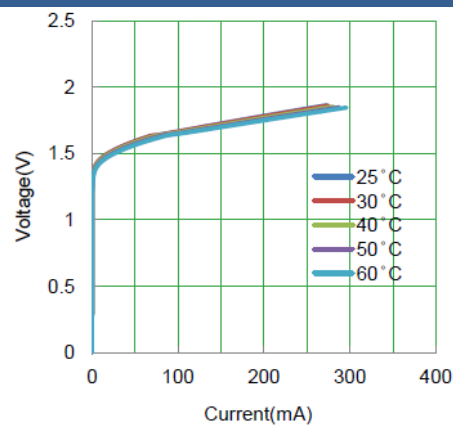

Operating Current vs. Temperature

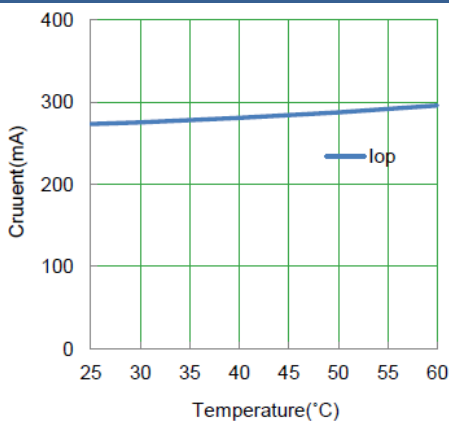

Threshold Current vs. Output Power

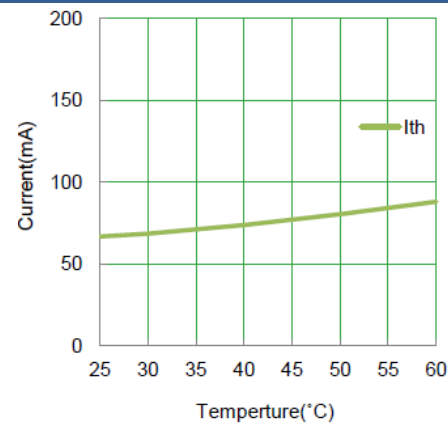

Wavelength vs. Temperature

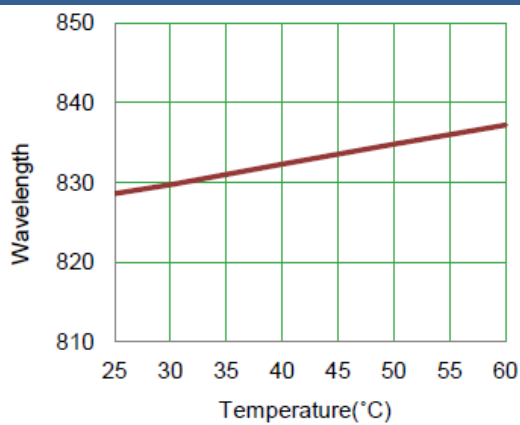

Θ_{||} / Θ_⊥ Beam Divergence

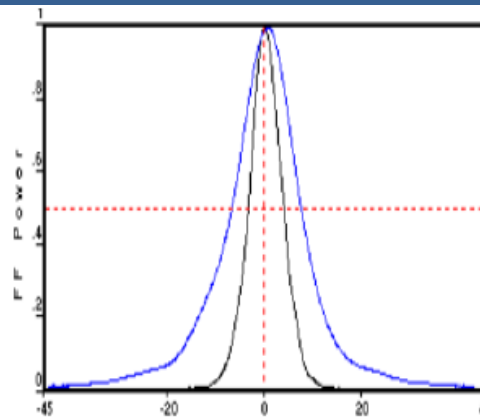



Electrical Connection

Pin Configuration

Pin #	Function
Pin 1	LD Cathode
Pin 2	LD Anode, PD Cathode
Pin 3	PD Anode

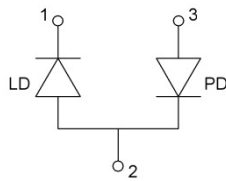

Bottom View

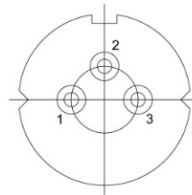

Outline Dimensions

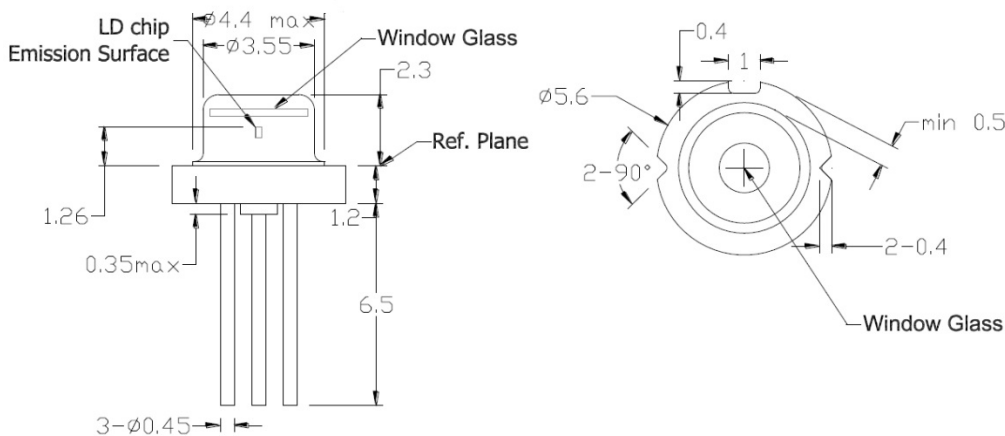

All dimensions in mm

Precautions

Safety

Caution: Laser light emitted from any laser diode may be **harmful to the human eye**. Avoid looking directly into the laser diode's aperture when the diode is in operation.

Note: The use of optical lenses with this laser diode will increase eye hazard

ESD caution

Always do handle laser diodes with extreme care to **prevent electrostatic discharge**, the primary cause of unexpected diode failure. To prevent ESD related failures, it is strongly advised to always **wearing wrist straps**, and **grounding all applicable work surfaces**, when handling laser diodes

Operating Considerations

It is strongly advised to only operate this laser diode with a current source. The current of a laser diode is an exponential function of the voltage across it. **Usage of current regulated drive circuits is mandatory**. Laser diodes may be damaged by excessive drive currents or switching transients

It is advised, to operate the laser diode at the lowest temperature possible, and to never exceed maximum specifications as outlined in the datasheet. Device degradation will accelerate with increased temperature. **Proper heat sinking will greatly enhance stability and life time of the laser diode**