



ROITHNER LASERTECHNIK GmbH

WIEDNER HAUPTSTRASSE 76
TEL. +43 1 586 52 43 -O. FAX. -44

1040 VIENNA AUSTRIA
OFFICE@ROITHNER-LASER.COM



LD-520-30MG

- Green Laser Diode
- 520 nm, 30 mW
- Single transverse mode
- TO56 package, Flat Window



Description

LD-520-30MG is a direct emitting, **GaN based**, 520 nm green laser diode in 5.6 mm TO-Can **with integrated photodiode**. It offers single transverse mode emission and >100 Mhz modulation bandwidth. It is an efficient radiation source for many applications like **laser projection**, holography, metrology, or biomedical application.

Maximum Rating* ($T_{CASE} = 25^{\circ}C$)

Parameter	Symbol	Values		Unit
		Min.	Max.	
Operating Current*1	I_{MAX}		200	mA
Reverse Voltage	V_R		2	V
Operating Temperature*1	T_{OPR}	- 20	+ 60	$^{\circ}C$
Storage Temperature	T_{STG}	- 40	+ 85	$^{\circ}C$
Soldering Temperature (max. 3s)	T_{SOL}		+ 260	$^{\circ}C$
Junction Temperature*1	T_J		+ 150	$^{\circ}C$

* operating outside these conditions may damage the device

*1 operating at maximum ratings may influence the life time



Electro-Optical Characteristics ($T_{CASE} = 25^{\circ}C$, $P_o = 30mW$)

Parameter	Symbol	Values			Unit	
		Min.	Typ.	Max.		
Peak Wavelength	λ_P	510	520	530	nm	
Spectral Width (FWHM)	$\Delta\lambda$		2		nm	
Operating Voltage	V_F		6.5	8.0	V	
Threshold Current	I_{th}		50	75	mA	
Operating Current	I_F		100	140	mA	
Modulation Frequency	f		>100		MHz	
Polarization	P_{GR}		100:1			
Beam Divergence (FWHM)	parallel	$\Theta_{ }$	4	7	11	deg.
	perpendicular	Θ_{\perp}	16	22	25	deg.
Thermal Resistance (junction to case)	R_{th}		34		K/W	
Monitor Current	I_M		90			



Performance Characteristics

Optical Output Power vs. Operating Current

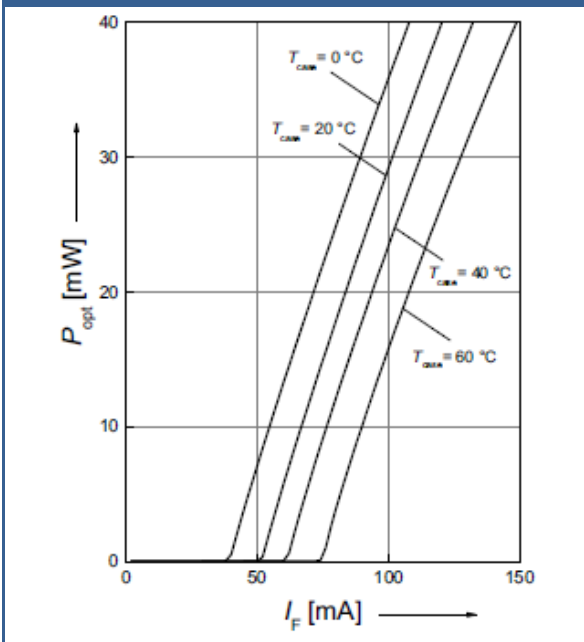

Operating Voltage vs. Operating Current

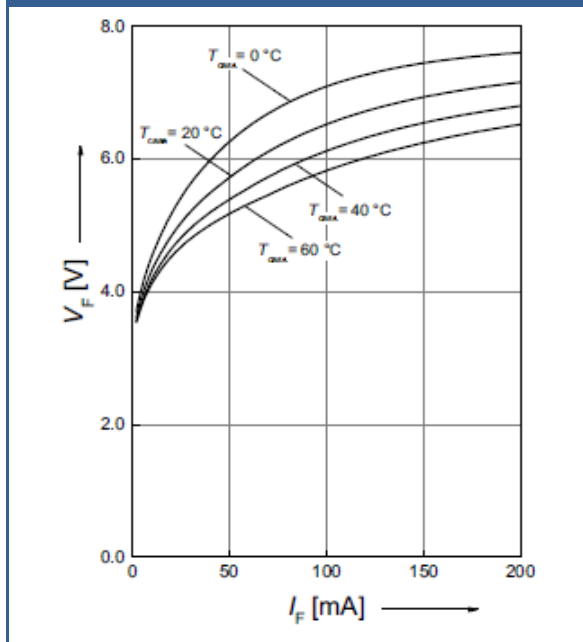

Threshold Current vs. Temperature

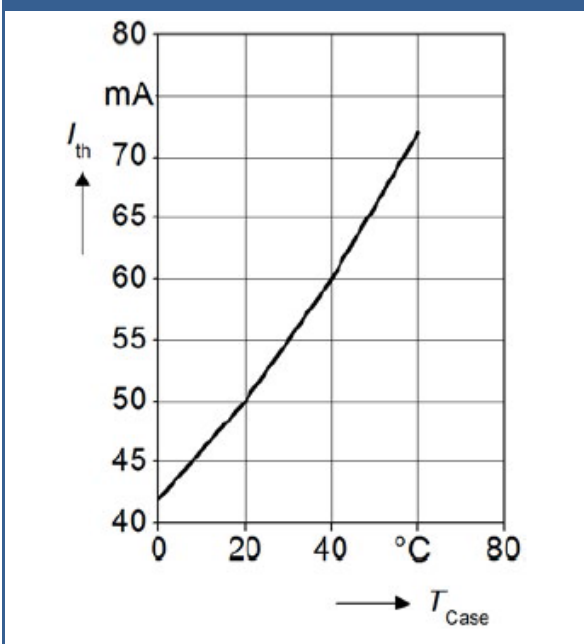

Relative Output Power vs. Wavelength

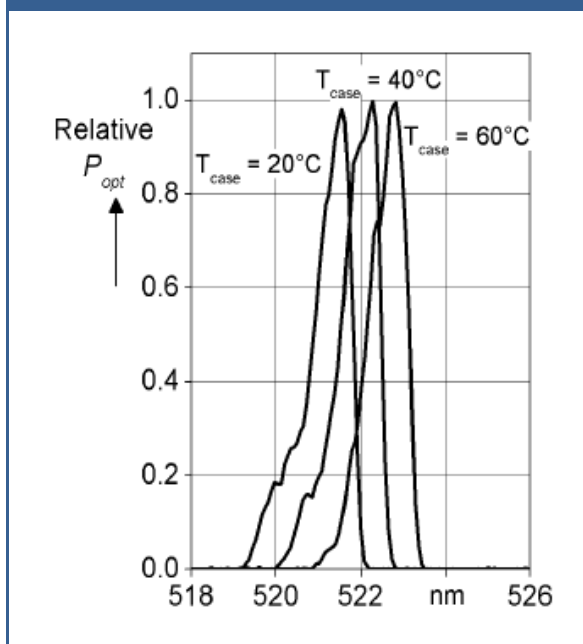



Beam Divergence

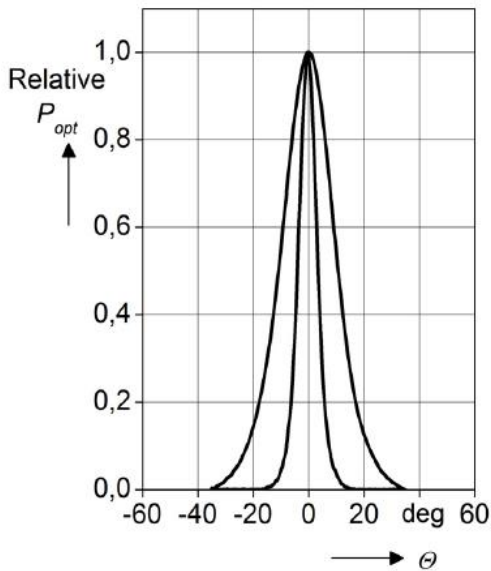

Max. operating Current vs. Temperature

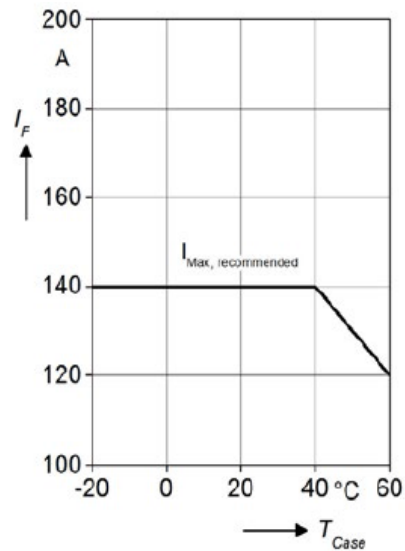

Electrical Connection

Pin Configuration

Pin #	Function
Pin 1	LD Cathode
Pin 2	LD Anode, PD Cathode
Pin 3	PD Anode

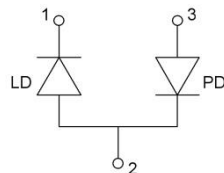

Bottom View

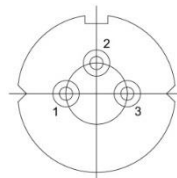

Outline Dimensions

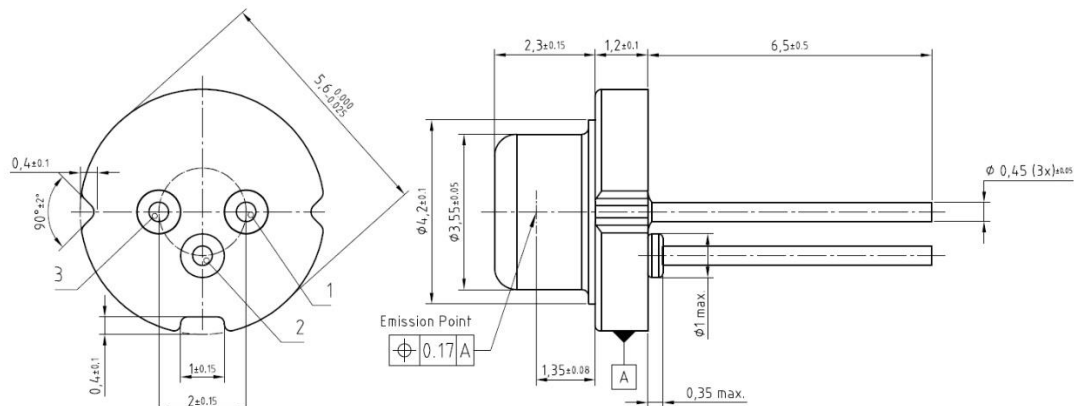

- 1: Cathode LD
- 2: Anode LD, Cathode PD
- 3: Anode PD

All dimensions in mm