



QL67F6S Series

- Red Laser Diode
- 670 nm, 10 mW CW
- Single Mode
- 5.6 mm TO package, flat window
- Built-in Monitor PD



Description

QL67F6S series are MOCVD grown band Gain-Guided type InGaAlP Laser Diode with quantum well structure. They are emitting at typical **670 nm** with rated output power of **10 mW CW** at room temperature. The **5.6 mm TO package** includes a cap and flat window, and contains a built in **monitor PD**.

Maximum Ratings

Parameter	Symbol	Values		Unit
		Min.	Max.	
Optical Output Power	P_O		12	mW
Laser Diode Reverse Voltage	V_{LDR}		2	V
Photo Diode Reverse Voltage	V_{PDR}		30	V
Operating Temperature	T_{CASE}	-10	+60	°C
Storage Temperature	T_{STG}	-40	+85	°C
Soldering Temperature	T_{SOLD}			°C

Specifications ($T_{CASE}=25^{\circ}C$)

Parameter	Symbol	Values			Unit
		Min.	Typ.	Max.	
Peak Wavelength	λ_P	660	670	680	nm
Optical Output Power	P_O	-	10	-	mW
Threshold Current	I_{TH}	-	40	60	mA
Forward Current	I_{OP}	-	50	70	mA
Forward Voltage	V_{OP}	-	2.3	2.6	V
Beam Divergence	$\theta_{ }$	7	8	11	deg.
Beam Divergence	θ_{\perp}	24	32	35	deg.
Beam Angle	$\Delta\theta_{ }$			± 1.5	deg.
Beam Angle	$\Delta\theta_{\perp}$			± 2.5	deg.
Positional Accuracy	$\Delta X, \Delta Y, \Delta Z$	-	-	± 60	μm
Mode Structure			SM		-
Monitor Current	I_M	0.1	0.3	0.5	mA



Electrical Connection

QL67F6SA

Lead	Description
PIN 1	LD Cathode
PIN 2	LD Anode, PD Cathode
PIN 3	PD Anode

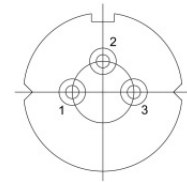
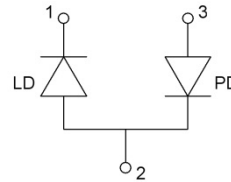

Bottom View

QL67F6SB

Lead	Description
PIN 1	LD Anode
PIN 2	LD Cathode, PD Cathode
PIN 3	PD Anode

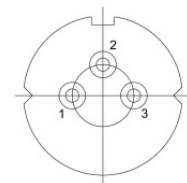
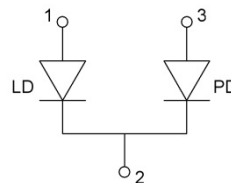

Bottom View

QL67F6SC

Lead	Description
PIN 1	LD Anode
PIN 2	LD Cathode, PD Anode
PIN 3	PD Cathode

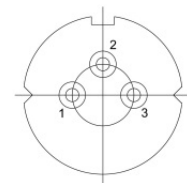
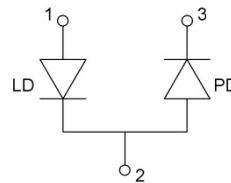

Bottom View



Drawing

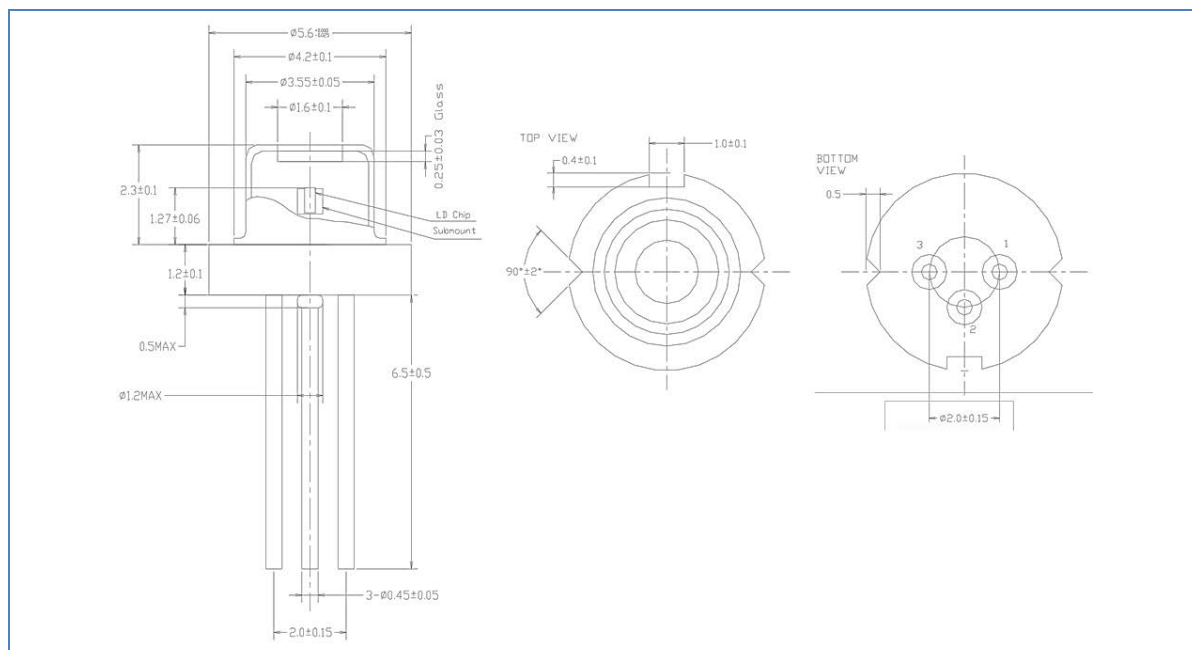

All dimensions in mm



Precautions

ESD Caution:

Always do handle laser diodes with extreme caution to prevent electrostatic discharge, the primary cause of unexpected diode failure. ESD failures can be prevented by always wearing wrist straps, only using a grounding workplace, and following strict anti-static guidelines when handling the laser diode.



Safety Advice:

This laser diode emits highly concentrated infrared light which can be **hazardous to the human eye and skin**. This diode is classified as **CLASS 3 laser product** according to **IEC 60825-1** and **21 CFR Part 1040.10 Safety Standards**.

Operating Considerations:

Operating the laser diode outside of its maximum ratings may cause failure or a safety hazard. The diode may be damaged by excessive drive currents or switching transients. If the diode is operated using a power supply, it is strongly recommended to connect the diode with the output voltage set to zero. The voltage should then be increased slowly and with great caution, while at the same time carefully monitoring the laser diodes output power and drive current. The laser diode will show accelerated degradation with increased temperature, and it is advised to keep the case temperature low therefor, by means of heat sinking the device.