

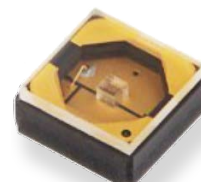

UVTOP270-FW-SMD

- Deep Ultraviolet Light Emission Source
- 275 nm, 2.0 mW
- 3535 Ceramic SMD Package
- Low Thermal Resistance
- Air and Water Sterilization



Description

UVTOP270-FW-SMD is a deep ultraviolet light emission source, based on **AlGaIn** quantum structures, typically emitting at **275 nm** with an optical output power of **2.0 mW**. It comes in hermetically sealed ceramic SMD package with a protective flat glass window, and **low thermal resistance**. **UVTOP270-FW-SMD** is widely used for forensic analysis, disinfection, **air and water sterilization**, protein analysis, DNA sequencing and drug discovery.

Maximum Rating ($T_{CASE} = 25^{\circ}C$)

Parameter	Symbol	Values		Unit
		Min.	Max.	
Power Dissipation, DC	P_D		210	mW
Forward Current*	I_F		30	mA
Operating Temperature*	T_{OPR}	- 30	+ 55	$^{\circ}C$
Storage Temperature	T_{STG}	- 30	+ 100	$^{\circ}C$

* Operation close to the absolute maximum ratings may affect device reliability

Electro-Optical Characteristics ($T_{CASE} = 25^{\circ}C$, $I_F = 20$ mA)

Parameter	Symbol	Values			Unit
		Min.	Typ.	Max.	
Peak Wavelength* ¹	λ_P	270		280	nm
Spectral Width (FWHM)	$\Delta\lambda$	9	11	15	nm
Forward Voltage* ²	V_F	5.0	6.0	7.0	V
Radiated Power* ³	P_O	1	2		mW
Beam Angle	$2\Theta_{1/2}$		125		deg.
Thermal Resistance	R_{th}		20		$^{\circ}C/W$

*¹wavelength measurement tolerance: ± 3 nm

*²forward voltage measurement tolerance: ± 3 %

*³output power measurement tolerance: ± 10 %





Performance Characteristics

Forward Current vs. Forward Voltage

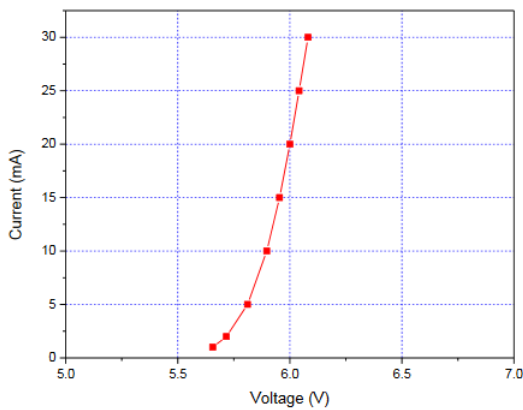

Rel. Optical Power vs. Forward Current

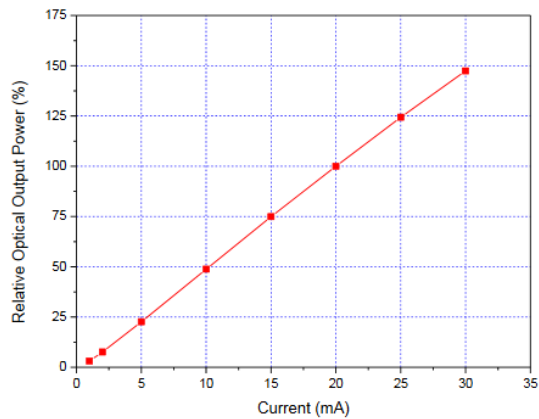

Peak Wavelength vs. Forward Current

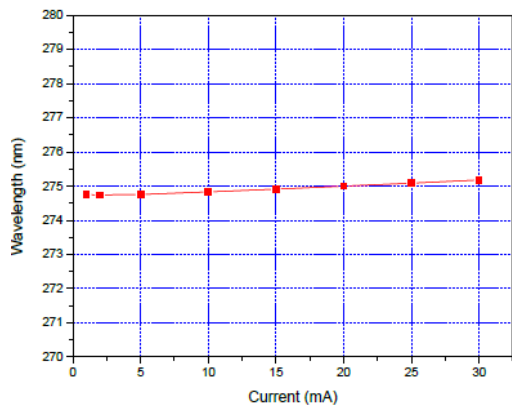

Rel. Optical Power vs. Case Temperature

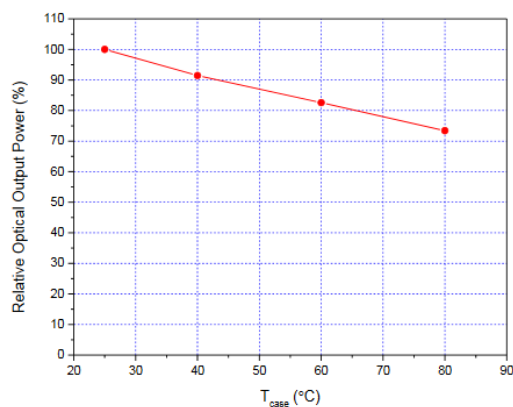

Peak Wavelength vs. Case Temperature*

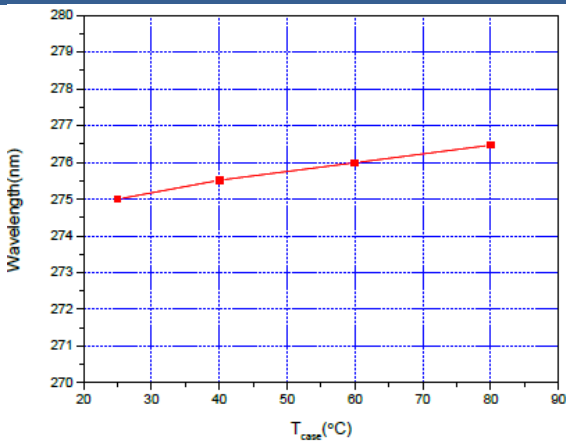

Forward Voltage vs. Case Temperature*

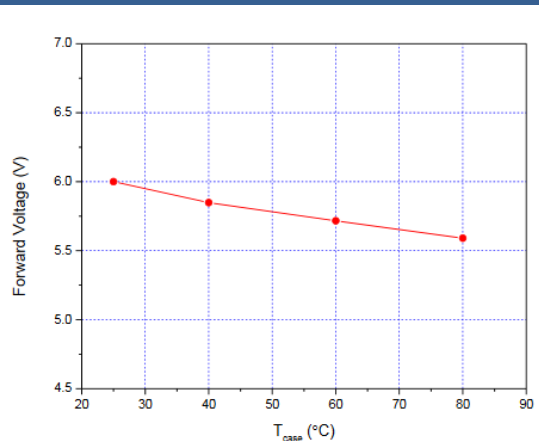

*temperature at the solder point



Performance Characteristics

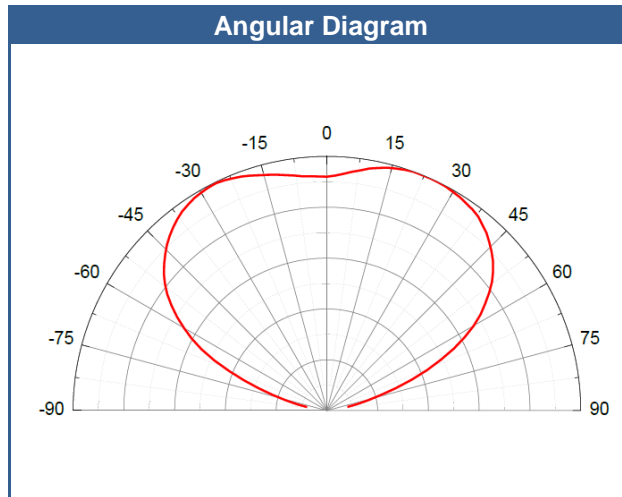
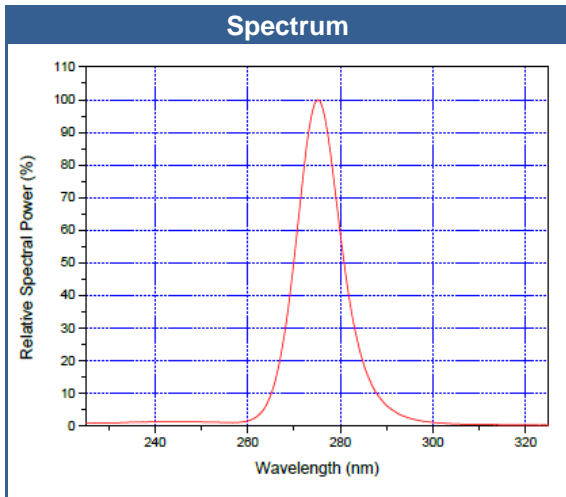

Outline Dimensions

3535 SMD package

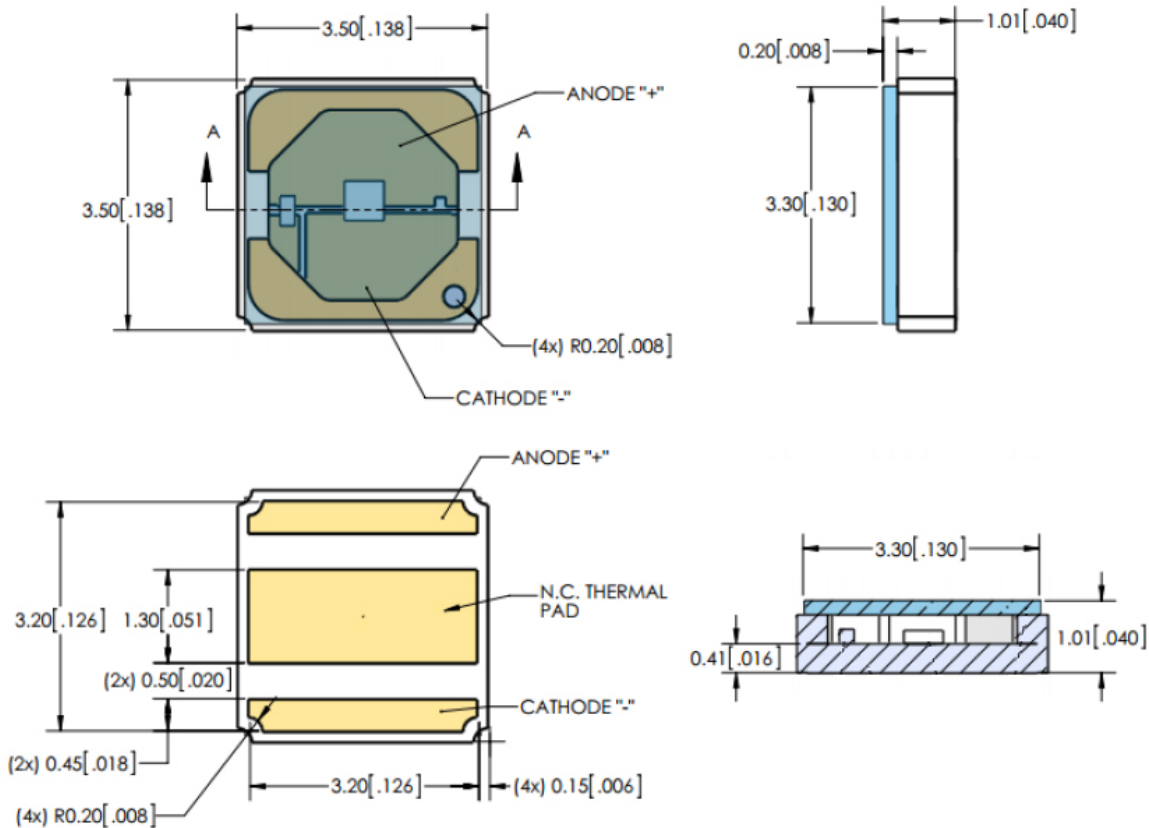

All dimensions in mm [in]



Packaging Information

All carrier tapes conform to EIA-481, Automated Component Handling Systems standard

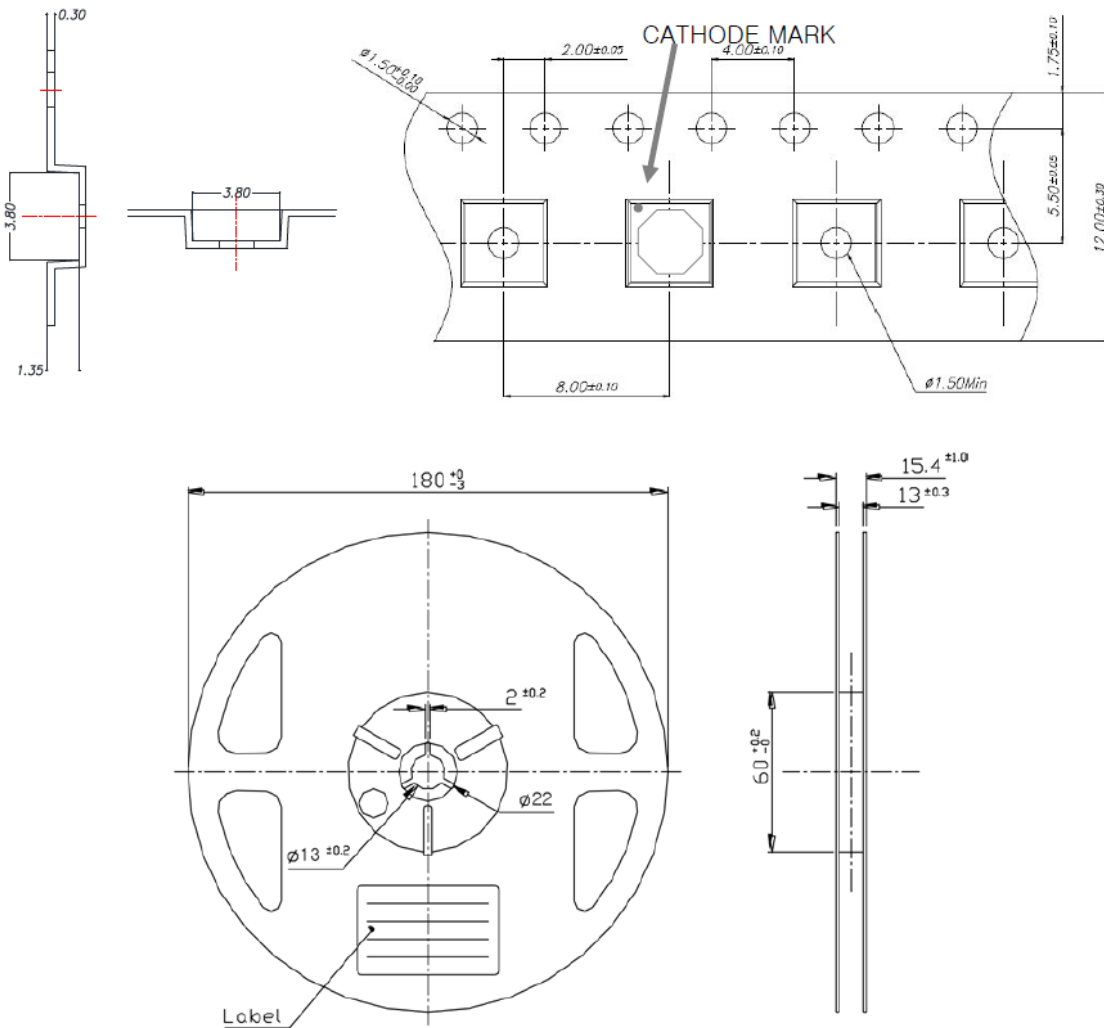

- all dimensions in mm
- 500 pcs / reel



Soldering Information

Recommended Solder Pad Layout

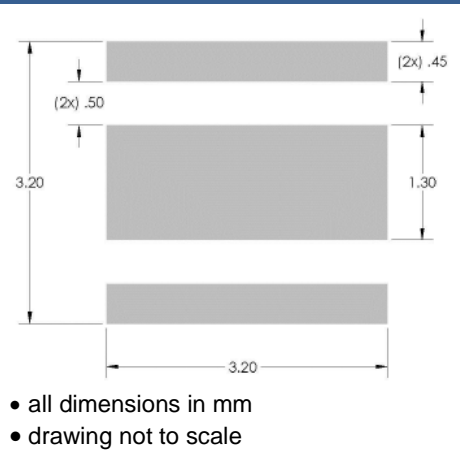

Recommended Reflow Soldering Profile

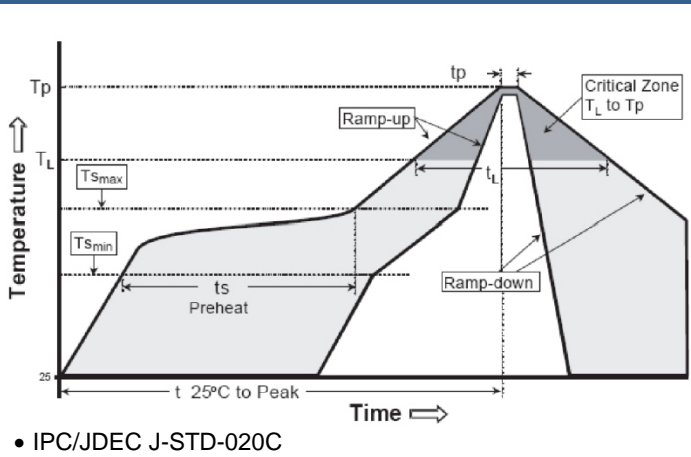

Profile Parameters	Lead-based Solder	Lead-free Solder
Average Ramp-Up Rate (T _S MAX to T _P)	< 3 °C/s	< 3 °C/s
Minimum Preheat Temperature (T _S MIN)	100 °C	150 °C
Maximum Preheat Temperature (T _S MAX)	150 °C	200 °C
Preheat Time (T _S MIN to T _S MAX)	60-120 s	60-180 s
Time Maintained Above: Temperature (TL)	183 °C	217 °C
Time Maintained Above: Time (tL)	60-90 s	60-90 s
Peak Temperature (T _P)	215 °C	228 °C
Time within 5 °C of Actual Peak Temp. (tp)	10-30 s	20-40s
Ramp-Down Rate	< 6 °C/s	< 6 °C/s
Time 25 °C to Peak Temperature	< 6 min.	< 8 min.

Reflow Information:

- UVTOP SMD reflow characteristics are compatible with JEDEC J-STD-020C
- **It is recommended to follow the solder profile of the solder paste manufacturer**
- It is recommended to evaluate the soldering process through several test PCB's and subsequent X-ray or shear testing of the devices
- The solder should show minimum indication of voids or solder grains.
- A "no clean" solder paste is recommended
- For consistent results a solder pencil printer or automated dispense system is suggested
- For cleaning after reflow, isopropyl alcohol or water is recommended
- Do not use ultrasonic cleaning

Do not wave solder or hand solder UVTOP SMD LEDs



Precautions for Use

Cleaning:

Cleaning with isopropyl alcohol or water recommended

DO NOT USE ultrasonic cleaners

Static Electricity:

UVTOP are sensitive to electrostatic discharge (ESD). Precautions against ESD must be taken when handling or operating these LEDs. Surge voltage or electrostatic discharge can result in complete failure of the device.

UV-Radiation:

During operation these LEDs do emit **high intensity ultraviolet light**, which is hazardous to skin and eyes, and may cause cancer. Do avoid exposure to the emitted UV light. **Protective glasses are recommended.** It is further advised to attach a warning label on products/systems that do utilize UV-LEDs:



Operation:

- **Do only operate UVTOP LEDs with a current source.**
Current of a LED is an exponential function of the voltage across it. Usage of current regulated drive circuits is mandatory.
- Compliance to the maximum electrical specifications is paramount.
- Do never exceed the absolute maximum rating of the product.
- These LEDs are not designed to be used under negative bias.
- These LEDs are not designed to be used in any type of fluid (water, oil, organic solvent,...)
- These LEDs are susceptible to heat generation. Use care to design an end product with adequate thermal management to ensure LEDs do not exceed maximum recommended temperatures.

ANY ATTEMPT TO DRIVE THESE LEDS WITH A VOLTAGE SOURCE WILL CAUSE DAMAGE AND POSSIBLE COMPLETE FAILURE OF THE PRODUCT

Storage:

- It is recommended to store UVTOP LEDs in a moisture proof bag with a desiccant, and to reseal the bag after opening.
- If the LEDs are stored for more than 3 months, a sealed container with nitrogen atmosphere should be used
- **Recommended storage temperature: 5-30 °C**
- **Recommended storage relative humidity: < 50 %**
- Prolonged exposure to moisture can adversely affect the performance of the LEDs
- If the bag has been opened for more than 168 hours, and the color of the desiccant changes, the LEDs should be dried for 10-12 hours at 55-65 °C
- The conditions for resealing are as follows: Temperature 5-40 °C, relative humidity < 30 %



Handling:

- Do not rapidly cool the device after soldering
- Do not apply mechanical stress or excess vibration during the cooling process
- LEDs should not be mounted on warped areas of the PCB
- **Do not touch the glass lens with any sharp tools such as tweezers**

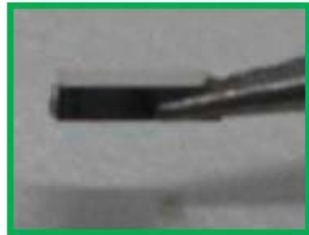

- Avoid leaving fingerprints on the glass lens
- Do avoid any excessive mechanical pressure on the LEDs surface
- Do not handle this product with acid or sulfur material in sealed space

© All Rights Reserved

The above specifications are for reference purpose only and subjected to change without prior notice