

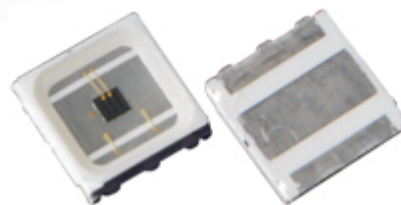

SMB1N-970

- Infrared High Power LED
- 970 nm, 30 mW
- SMD package, PA9T
- Dimension: 5.0 x 5.2 x 1.0 mm
- Viewing Angle: 134°



Description



SMB1N-970 is a surface mount GaAs High Power LED with a typical peak wavelength of **970 nm** and radiation of **30 mW**. It comes in SMD package (PA9T) with silver plated soldering pads (lead free solderable), copper heat sink, and molded with silicone resin.

Maximum Ratings ($T_{CASE}=25^{\circ}C$)

Parameter	Symbol	Values		Unit
		Min.	Max.	
Power Dissipation	P_D		1100	mW
Forward Current	I_F		600	mA
Pulse Forward Current * ¹	I_{FP}		3000	mA
Reverse Voltage	V_F		5	V
Thermal Resistance	R_{THJA}		4	KW
Junction Temperature	T_J		120	°C
Operating Temperature	T_{CASE}	- 40	+ 100	°C
Storage Temperature	T_{STG}	- 40	+ 100	°C
Lead Solder Temperature * ²	T_{SLD}		+ 250	°C

*¹ duty=1%, pulse width = 10 μ s

*² must be completed within 5 seconds

Electro-Optical Characteristics ($T_{CASE}=25^{\circ}C$)

Parameter	Symbol	Conditions	Values			Unit
			Min.	Typ.	Max.	
Peak Wavelength	λ_P	$I_F=400mA$	960	970	980	nm
Half Width	$\Delta\lambda$	$I_F=400mA$		50		nm
Forward Voltage	V_F	$I_F=350mA$		1.4	1.7	V
	V_{FP}	$I_{FP}=3A$		2.6	4.0	
Radiated Power * ¹	P_O	$I_F=400mA$		30		mW
		$I_{FP}=3A$		220		
Radiant Intensity * ²	I_E	$I_F=400mA$		14		mW/sr
		$I_{FP}=3A$		100		
Viewing Angle	φ	$I_F=100mA$		134		deg.
Rise Time	t_R	$I_F=400mA$		2100		ns
Fall Time	t_F	$I_F=400mA$		2400		ns

*¹ measured by S3584-08

*² measured by CIE127-2007 Condition B



Typical Performance Curves

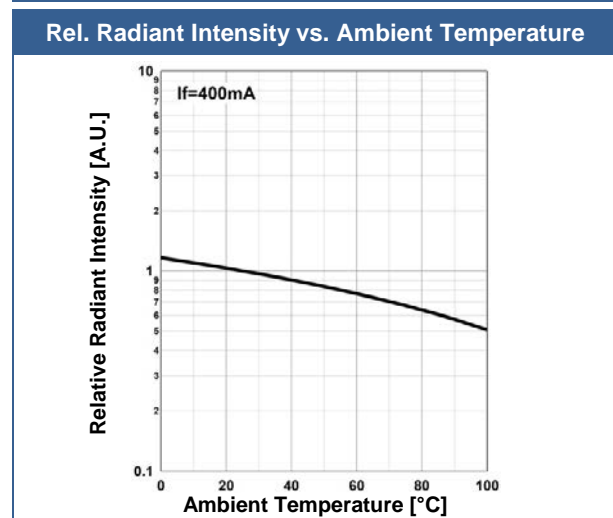
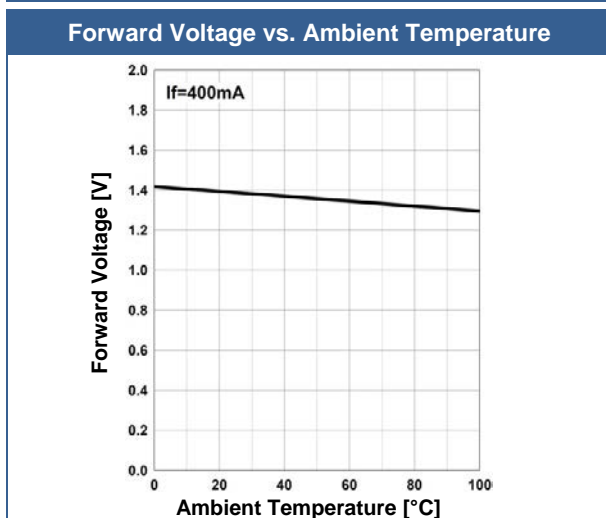
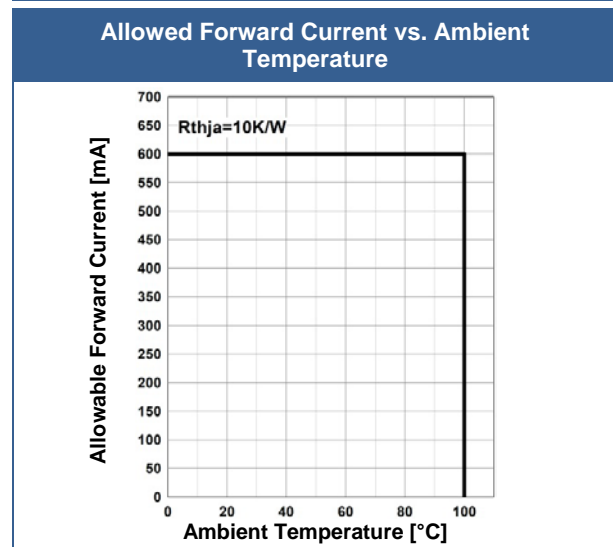
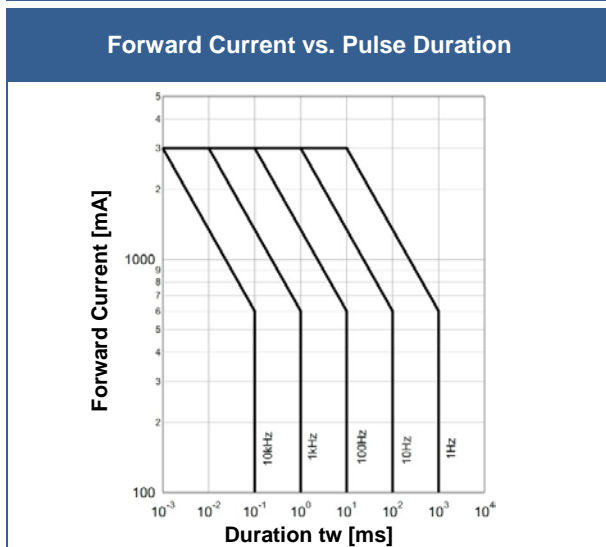
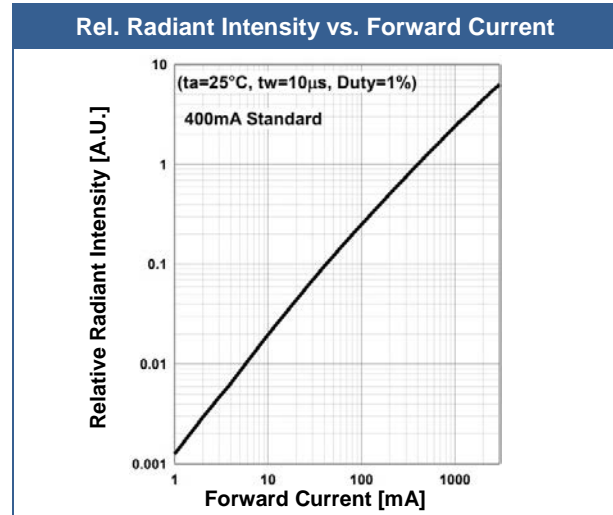
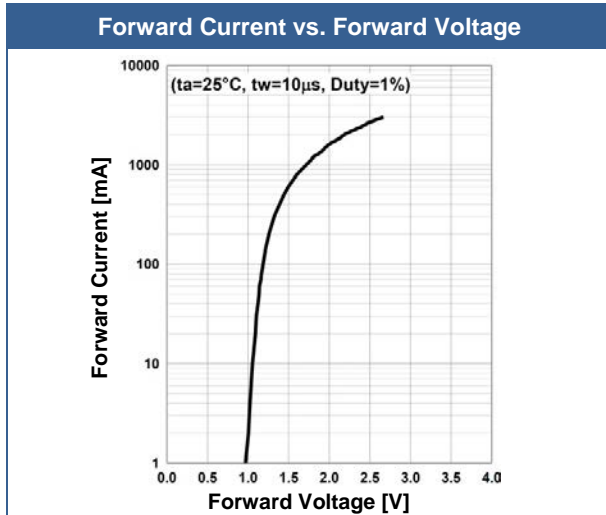



Peak Wavelength vs. Ambient Temperature

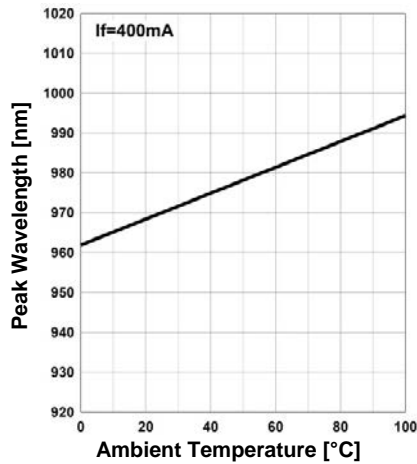

Relative Spectral Emission

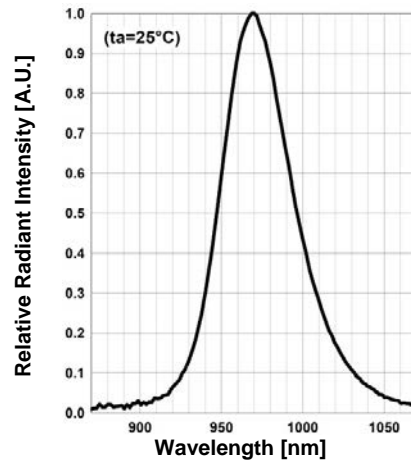

Radiation Characteristics

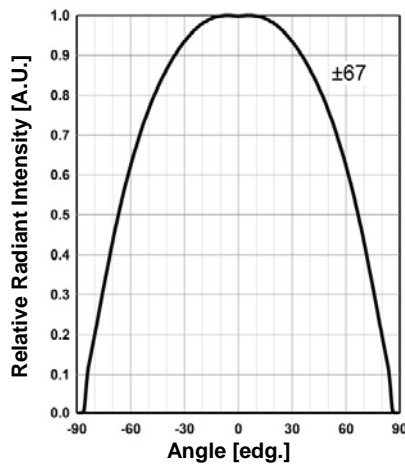

Radiation Characteristics

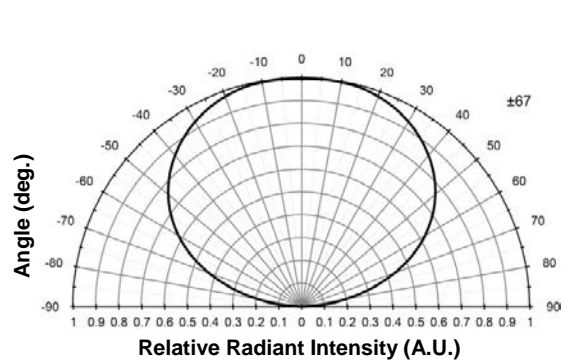

Outline Dimensions

SMB1N

flat

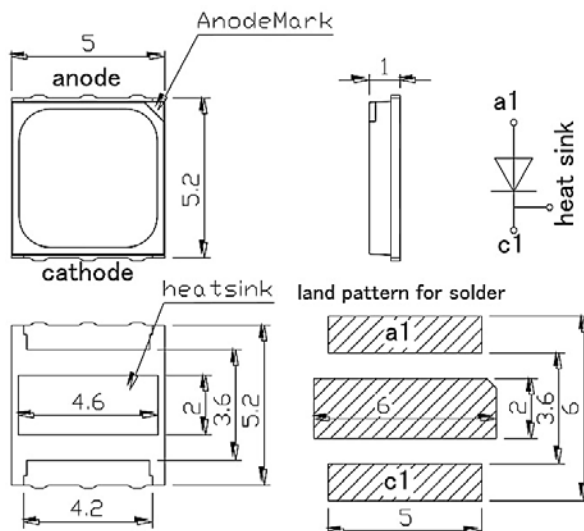

Lead	Description
Pin a1	LED Anode
Pin c1	LED Cathode

All Dimensions in mm



Precautions

Soldering:

- Do avoid overheating of the LED
- Do avoid electrostatic discharge (ESD)
- Do avoid mechanical stress, shock, and vibration
- Do only use non-corrosive flux
- Do not apply current to the LED until it has cooled down to room temperature after soldering

Recommended soldering conditions:

This LED is designed to be reflow soldered on to a PCB. If dip soldered or hand soldered, its reliability cannot be guaranteed.

Nitrogen reflow soldering is recommended. Air flow soldering conditions can cause optical degradation, caused by heat and/or atmosphere.

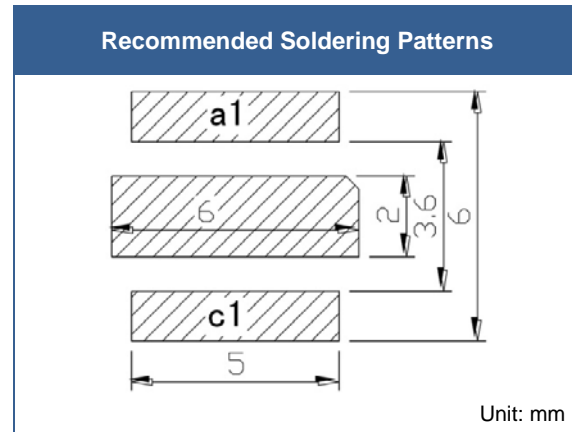
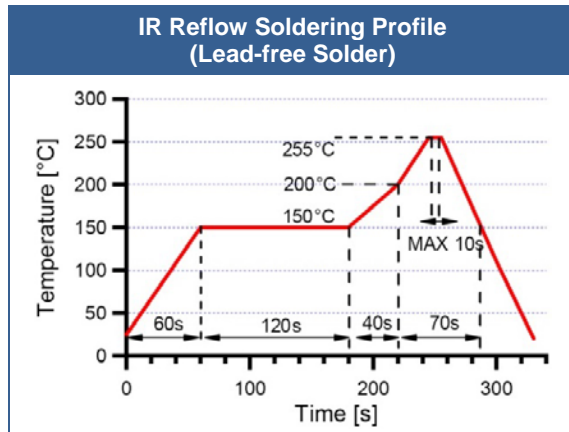

Above table specifies the maximum allowed duration and temperature during soldering. It is strongly advised to perform soldering at the shortest time and lowest temperature possible.

Cleaning:

Cleaning with isopropyl alcohol, propanol, or ethyl alcohol is recommended

DO NOT USE acetone, chloroform, trichloroethylene, or MKS

DO NOT USE ultrasonic cleaners

Static Electricity:

LEDs are sensitive to electrostatic discharge (ESD). Precautions against ESD must be taken when handling or operating these LEDs. Surge voltage or electrostatic discharge can result in complete failure of the device.

Radiation:

During operation these LEDs do emit **high intensity light**, which is hazardous to skin and eyes, and may cause cancer. Do avoid exposure to the emitted light. **Protective glasses are recommended.** It is further advised to attach a warning label on products/systems.

Operation:

Do only operate LEDs with a current source.

Running these LEDs from a voltage source will result in complete failure of the device.

Current of a LED is an exponential function of the voltage across it. Usage of current regulated drive circuits is mandatory.