



ROITHNER LASERTECHNIK GmbH

WIEDNER HAUPTSTRASSE 76
TEL. +43 1 586 52 43 -O. FAX. -44

1040 VIENNA AUSTRIA
OFFICE@ROITHNER-LASER.COM



UVLED-375-NC2

- Ultraviolet Light Emission Source
- 375 nm, 280 mW
- 3535 Ceramic with Silicone Resin
- ESD Protection Device

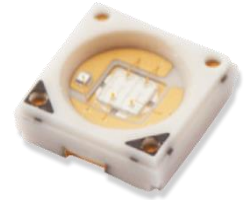

Description

UVLED-375-NC2 is an ultraviolet light emission source, typically emitting at **375 nm** with an optical output power of **280 mW** and narrow bandwidth. The hermetically sealed ceramic 3535 SMD package features **low thermal resistance**. UVLED-375-NC2 comes with integrated ESD protection device.

Maximum Rating ($T_{CASE} = 25^{\circ}C$)

Parameter	Symbol	Values		Unit
		Min.	Max.	
Power Dissipation	P_D		2.90	W
Forward Current	I_F		700	mA
Pulse Forward Current*	I_{FP}		1000	mA
Reverse Current	I_R		85	mA
Junction Temperature	T_J		+ 130	$^{\circ}C$
Operation Temperature	T_{OPR}	- 10	+ 85	$^{\circ}C$
Storage Temperature	T_{STG}	- 40	+ 100	$^{\circ}C$

* I_{FP} conditions with pulse width $\leq 10ms$ and duty cycle $\leq 10\%$

Electro-Optical Characteristics ($T_{CASE} = 25^{\circ}C$, $I_F = 500 mA$)

Parameter	Symbol	Values			Unit
		Min.	Typ.	Max.	
Peak Wavelength	λ_P	370	375	380	nm
Radiated Power	P_O		280		mW
Spectral Width (FWHM)	$\Delta\lambda$		9		nm
Forward Voltage	V_F		3.6		V
Beam Angle	$2\Theta_{1/2}$		120		deg.
Thermal Resistance	R_{th}		11.2	12.6	$^{\circ}C/W$

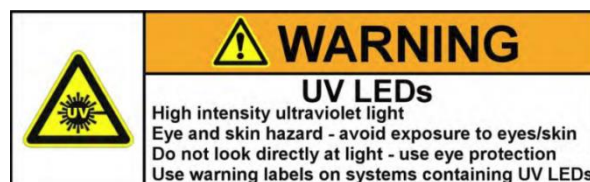



Performance Characteristics ($T_{CASE} = 25^{\circ}C$)

Forward current vs. Forward Voltage

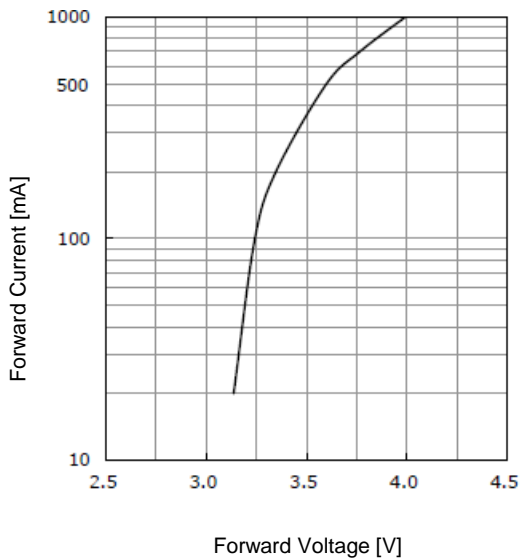

Forward Voltage vs. Ambient Temp.

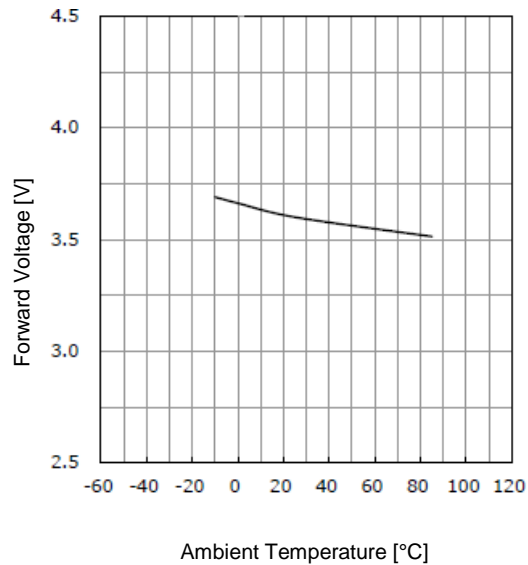

Radiant Flux vs. Forward Current

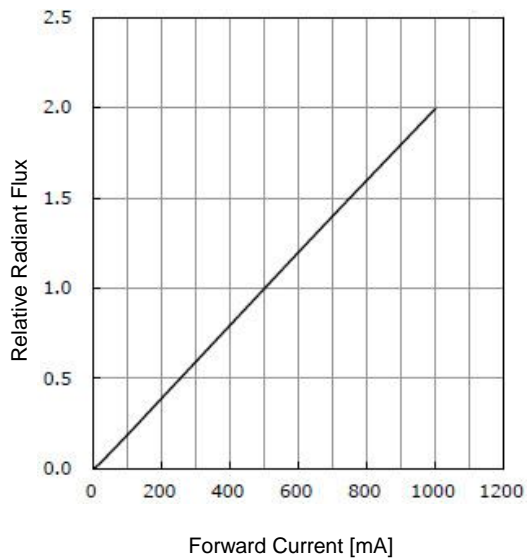

Radiant Flux vs. Ambient Temp.

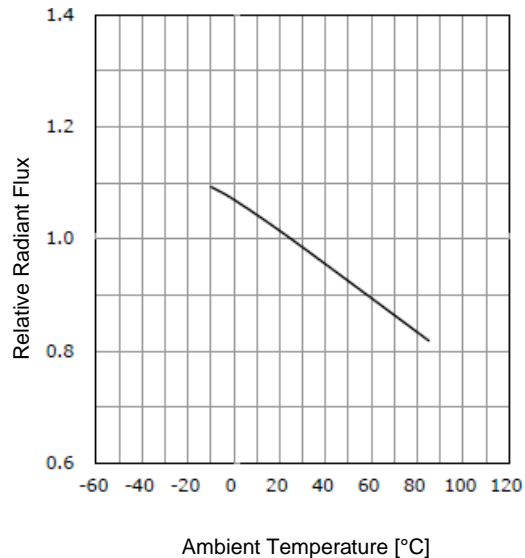



Performance Characteristics ($T_{CASE} = 25^{\circ}C$)

Peak Wavelength vs. Forward Current

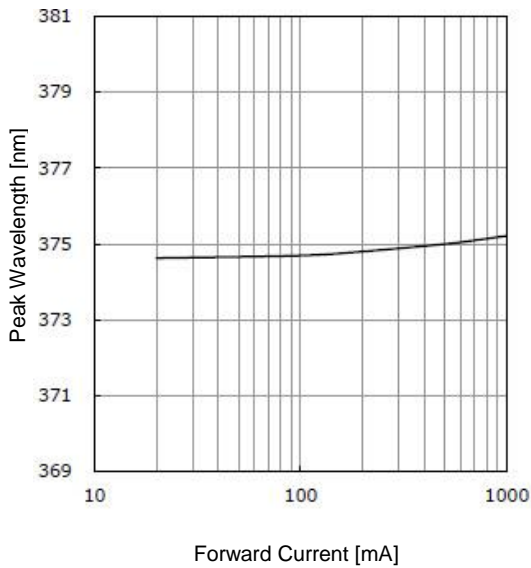

Peak Wavelength vs. Ambient Temp.

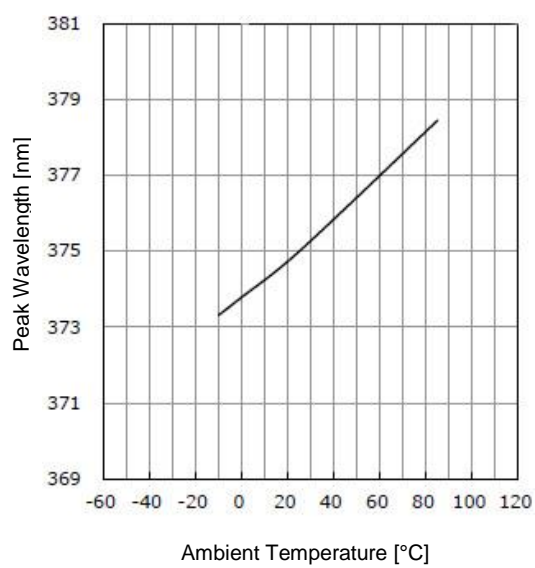

Spectrum

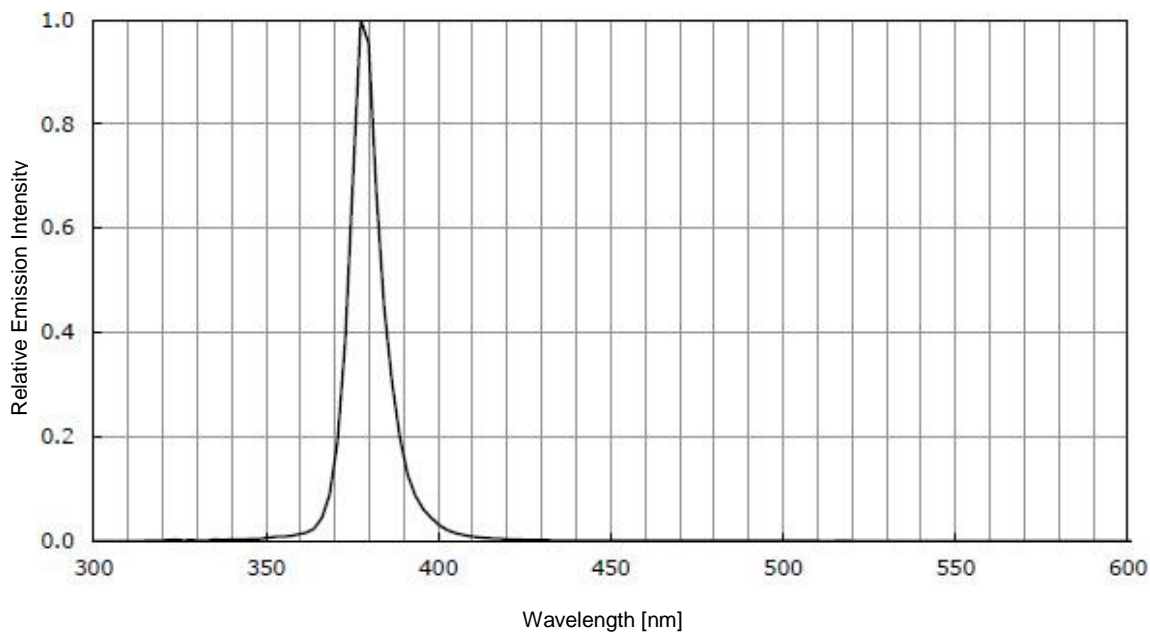



Performance Characteristics ($T_{CASE} = 25^{\circ}C$)

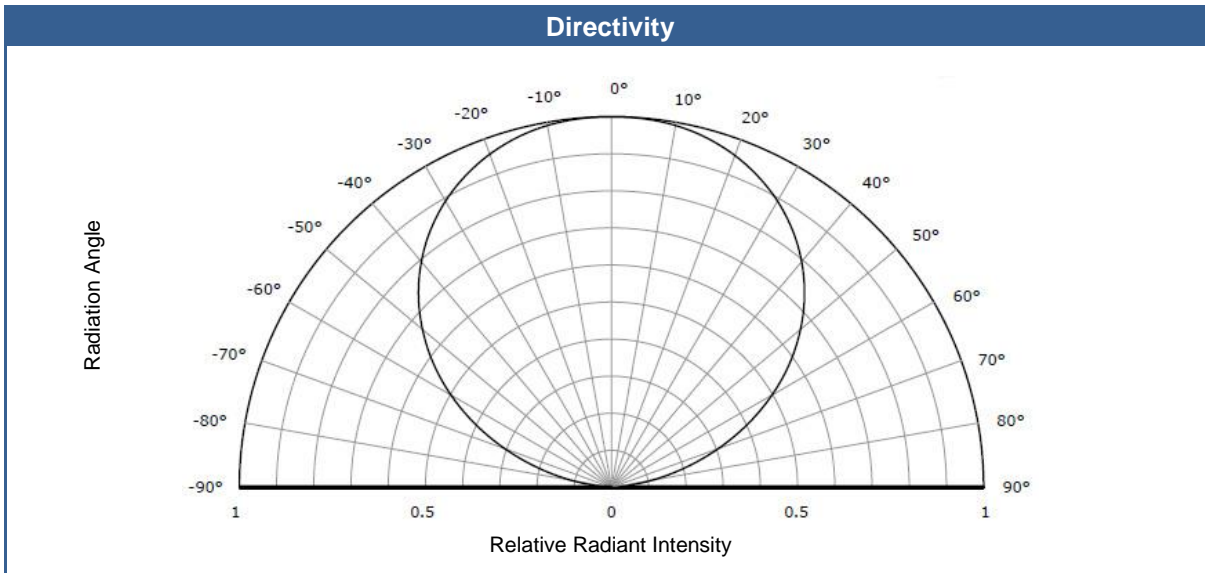

Outline Dimensions

3535 SMD package

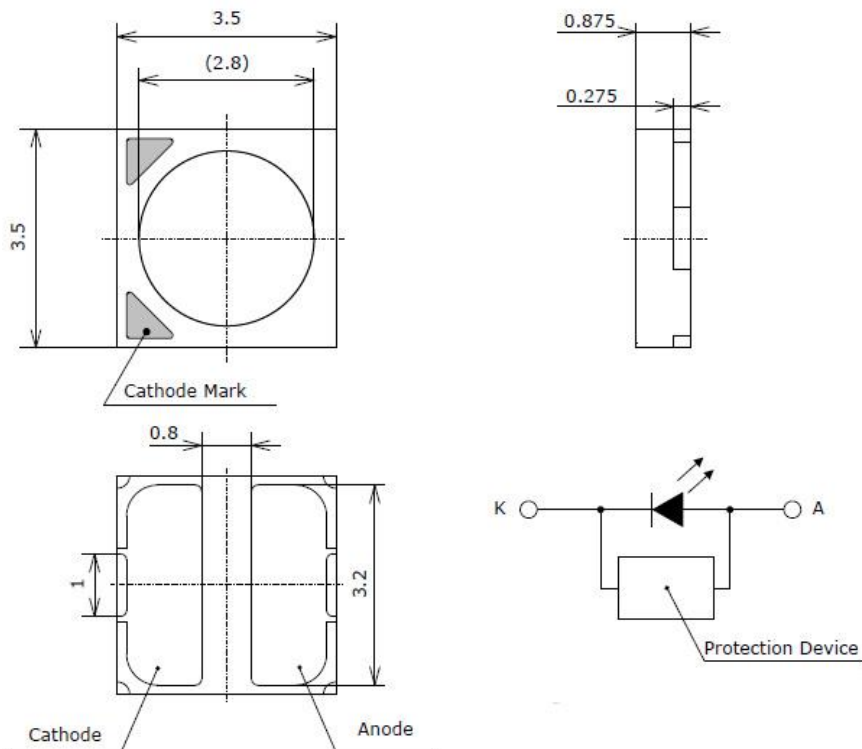

All dimensions in mm



Device Materials

Pin #	Material
Package	Ceramics
Encapsulation	Silicone resin
Electrodes	Au-plated



Soldering Information

Recommended Solder Pad Layout

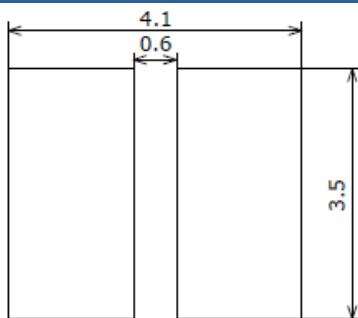

- all dimensions in mm
- drawing not to scale

Recommended Reflow Soldering Profile

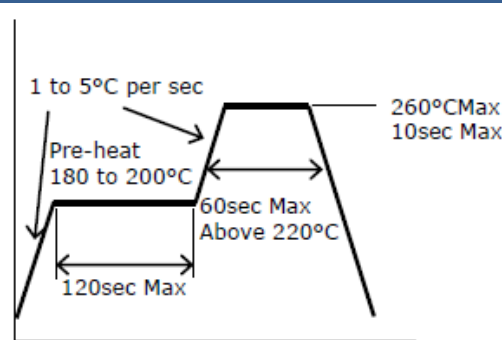

- IPC/JDEC J-STD-020C

Precautions for Use

Static Electricity:

LEDs are sensitive to electrostatic discharge (ESD). Precautions against ESD must be taken when handling or operating these LEDs. Surge voltage or electrostatic discharge can result in complete failure of the device.

UV-Radiation:

During operation these LEDs do emit **high intensity ultraviolet light**, which is hazardous to skin and eyes, and may cause cancer. Do avoid exposure to the emitted UV light. **Protective glasses are recommended.** It is further advised to attach a warning label on products/systems that do utilize UV-LEDs:

Operation:

- **Do only operate these LEDs with a current source.**
Current of a LED is an exponential function of the voltage across it. Usage of current regulated drive circuits is mandatory.
- Compliance to the maximum electrical specifications is paramount.

Storage:

- **Recommended storage temperature: $\leq 30\text{ }^{\circ}\text{C}$**
- **Recommended storage relative humidity: $\leq 70\text{ }%$**