



# ROITHNER LASERTECHNIK GmbH

WIEDNER HAUPTSTRASSE 76  
TEL. +43 1 586 52 43 -O. FAX. -44

1040 VIENNA

AUSTRIA

OFFICE@ROITHNER-LASER.COM



## RLT425-10MG

- Blue Laser Diode
- 425 nm, 10 mW
- Single Transverse Mode
- 5.6 mm TO Package



### Description

**RLT425-10MG** is a blue **single transverse mode** laser diode, based on InGaN quantum structure, with a peak wavelength of 425 nm, and **narrow peak wavelength tolerance of  $\pm 2$  nm** ( $\pm 1$ nm optionally available). **RLT425-10MG** comes in 5.6 mm TO-Can package.

### Maximum Ratings\*

Parameter	Symbol	Values		Unit
		Min.	Max.	
Reverse Voltage	$U_R$		5	V
Optical Output Power	$P_O$		40	mW
Operating Temperature	$T_{OPR}$	0	+ 50	°C
Storage Temperature	$T_{STG}$	- 20	+ 80	°C
Soldering Temperature (max. 3s)	$T_{SOL}$		+ 260	°C

\* Operating close to or outside these conditions may damage the device

### Electro-Optical Characteristics ( $T_{CASE} = 20^\circ\text{C}$ , $P_O = 10 \text{ mW}$ )

Parameter	Symbol	Values			Unit	Condition
		Min.	Typ.	Max.		
Peak Wavelength [ $T_{CASE}=20^\circ\text{C}$ ]	$\lambda_P$	<b>423</b>	425	<b>427</b>	nm	$P_O=10\text{mW}$
Peak Wavelength [ $T_{CASE}=20^\circ\text{C}$ ]	$\lambda_P$	<b>424*</b>	425	<b>426*</b>	nm	$P_O=10\text{mW}$
Spectral Width (FWHM)	$\Delta\lambda$		1		nm	$P_O=10\text{mW}$
Temperature Coefficient	$\Delta\lambda/\Delta T$		0.05		nm/°C	$P_O=10\text{mW}$
Operating Voltage	$U_F$		4.5	7.0	V	$P_O=10\text{mW}$
Threshold Current	$I_{th}$		40	95	mA	$P_O=10\text{mW}$
Operating Current	$I_F$		60	115	mA	$P_O=10\text{mW}$
Beam Divergence (FWHM)	parallel	$\Theta_{  }$	7		deg.	$P_O=10\text{mW}$
	perpendicular	$\Theta_{\perp}$	30		deg.	$P_O=10\text{mW}$

\*  $\pm 1$ nm available optionally



### Electrical Connection

Pin Configuration [subject to change]

Pin #	Function
Pin 1	LD Anode
Pin 2 [case]	Not connected
Pin 3	LD Cathode

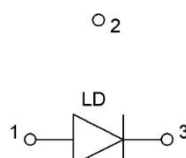

Bottom View

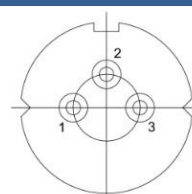



## Outline Dimensions

### 5.6 mm TO-Can

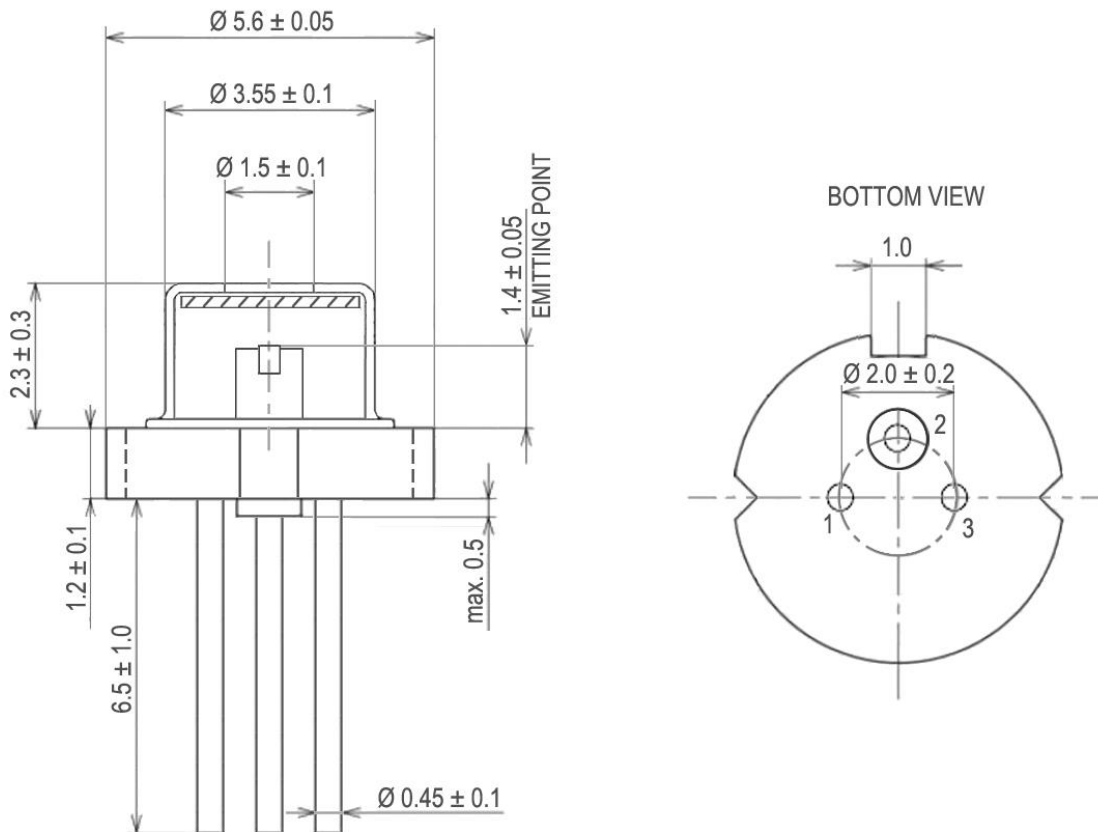

All dimensions in mm

## Precautions

### Safety

**Caution:** Laser light emitted from any laser diode may be **harmful to the human eye**. Avoid looking directly into the laser diode's aperture when the diode is in operation.

**Note:** The use of optical lenses with this laser diode will increase eye hazard

### ESD caution

Always do handle laser diodes with extreme care to **prevent electrostatic discharge**, the primary cause of unexpected diode failure. To prevent ESD related failures, we do advise to always **wearing wrist straps**, and **grounding all applicable work surfaces**, when handling laser diodes.

### Operating considerations

We do advise to operate this laser diode with a current source only. The current of a laser diode is an exponential function of the voltage across it. **Usage of current regulated drive circuits is mandatory**. Laser diodes may be damaged by excessive drive currents or switching transients.

**Proper heat sinking will greatly enhance stability and lifetime of the laser diode**